



The Corte Madera
Climate Change Adaptation Plan

November 2020





table of contents

INTRODUCTION.....	1
1. PLANNING FOR CLIMATE CHANGE	6
The Plan	8
<i>Plan Phases</i>	8
<i>Plan Vision</i>	8
<i>Guiding Principles</i>	9
<i>Plan Goals</i>	10
Planning Approach	12
<i>Local and State Policy Context</i>	12
<i>Build on Regional County Assessments and Planning</i>	13
<i>Regional Collaboration</i>	13
<i>Stakeholder Engagement</i>	14
<i>Understanding Town and Community Values</i>	16
<i>Adaptation Library</i>	16
<i>Evaluating Adaptation Actions</i>	17
<i>Adaptation Pathways Approach to Planning</i>	19
<i>Strategic Planning in Corte Madera</i>	21
Climate Change and Corte Madera	22

<i>Wildfire</i>	24
<i>Sea Level Rise</i>	26
<i>Extreme Heat</i>	30
<i>Drought</i>	31
<i>Inland Flooding</i>	32
2. TOWN-WIDE.....	36
Health and Wellness.....	38
Emergency Preparedness.....	42
Resilient Infrastructure	48
Collaborate and Educate.....	52
3. THE SHORELINE	54
Protect.....	61
Accomodate.....	64
Retreat.....	68
Nature-Based Adaptation.....	72
Shoreline Focus Areas	74
<i>Lucky Drive</i>	76
<i>Paradise Drive</i>	77
<i>Mariner Cove & Marina Village</i>	78
<i>Corte Madera Marsh & Railroad Right of Way</i>	86
4. THE HILLSIDES.....	96
Evacuate.....	100
<i>Investing in Infrastructure</i>	104
Mitigate.....	110
Protect.....	116
Educate	118
5. CENTRAL CORTE MADERA	122
Collaborate.....	126
Prevent	132
6. CONCLUSION	138
ENDNOTES.....	142
APPENDICES	
References	146



1855 watercolor painting of Mount Tamalpais by William McMurtrie.

LIST OF FIGURES

- Figure 1.1. A map of Corte Madera, Marin County, and the State of California.
- Figure 1.2. Early development in Corte Madera in 1926.
- Figure 1.3. Low-fill (A) and high-level fill development (B) progression from the 1960's in Corte Madera.
- Figure 1.4. The five phases of the Corte Madera Adaptation and Resilience Plan.
- Figure 1.5. A screenshot of the landing page on the Corte Madera Adapts website.
- Figure 1.6. A high-level overview of the stakeholder engagement activities and timeline for the Corte Madera Adaptation Plan.
- Figure 1.7. A graphic representing how Policies, Programs, and Projects can be braided together to strengthen the Town's efforts to build resilience.
- Figure 1.8. The figure illustrates the evaluation process for adaptation actions through Tier 1, Tier 2, and possibly Tier 3 screening.
- Figure 1.9. This graphic depicts an adaptation pathway approach to planning, which includes the conceptual phasing of actions with certain triggers (SLR in this example) rather than by a chronological timeline.
- Figure 1.10. This map shows the different focus areas (Shoreline, Hillside, Central) discussed throughout the Adaptation Plan.
- Figure 1.11. Graphic representation of the components of climate vulnerability.
- Figure 1.12. Climate exposures summary of Corte Madera.
- Figure 1.13. Corte Madera's Wildland Urban Interface zone as dictated by the Central Marin Fire Department data developed for the upcoming Community Wildfire Protection Plan (CWPP) update set to be published in 2021.
- Figure 1.14. Town of Corte Madera sea level rise projections.
- Figure 1.15. Flood inundation map of Corte Madera depicting a water inundation scenario of three feet above mean higher high water (MHHW).
- Figure 1.16. A schematic depicting groundwater inundation before (A) and after SLR and tidal forcing (B). Illustrations: Kristina Hill.
- Figure 1.17. A composite map showing the combined Wildland Urban Interface (in red with black building outlines) and the FEMA 1% Annual Chance Flood Zone (in blue, with yellow building footprints).
- Figure 2.1. The Corte Madera General Plan (2009).
- Figure 2.2. The Corte Madera area and Marin mutual threat zone plan evacuation zone maps.
- Figure 2.3. The regional transportation connections to and from Corte Madera including major highways, roads, and the ferry system.
- Figure 3.1. Flood inundation maps depicting the MHHW +1 (top), 3 (middle), and 5.5 (bottom) feet water inundation scenarios.
- Figure 3.2. Example of multiple "gray" (traditional) and "green" (nature-based) adaptation actions working in concert to provide flood protection and habitat benefits.
- Figure 3.3. Submerged aquatic vegetation, mudflats, and coarse beaches are natural features that can reduce the impact of wave action on the shoreline.
- Figure 3.4. Map highlighting areas within the Shoreline focus area with additional conceptual adaptation strategies described in the following pages.
- Figure 3.5. Section of Lucky Drive under a MHHW + 1 ft. scenario (approximately equivalent to a king tide).
- Figure 3.6. East Paradise Drive under a MHHW + 5.5 ft. scenario.
- Figure 3.7. Graphic representing a potential inner levee alignment and tide gate designed to protect Mariner Cove and Marina Village.
- Figure 3.8. Graphic representing a potential outer levee alignment and tide gate designed to protect Mariner Cove and Marina Village.
- Figure 3.9. Earthen levee cross-section for Marina Village outer alignment (Option 1).
- Figure 3.10. Block wall cross-section for Marina Village outer alignment (Option 2).
- Figure 3.11. Sheet pile wall cross section for Marina Village outer alignment (Option 3).
- Figure 3.12. Earthen levee cross-section for inner alignment and Mariner Cove (Option 1).
- Figure 3.13. Block wall cross-section for inner alignment and Mariner Cove (Option 2).
- Figure 3.14. Sheet pile wall cross-section for inner alignment and Mariner Cove (Option 3).
- Figure 3.15. Preliminary project costs for flood protection levee and tide gate design, permitting, and construction.
- Figure 3.16. Adaptation pathway for Mariner Cove and Marina Village.
- Figure 3.17. Potential location for an integrated adaptation strategy for the marsh and railroad alignment.
- Figure 3.18. Map of the marsh area showing public and non-profit land ownership.
- Figure 3.19. Conceptual design for potential restoration and adaptation options at Corte Madera Marsh and the railroad right-of-way.
- Figure 3.20. Earthen levee cross-section for Railroad Right of Way (Option 1).
- Figure 3.21. Block wall cross-section for Railroad Right of Way (Option 2).
- Figure 3.22. Sheet pile wall cross section for Railroad Right of Way (Option 3).
- Figure 3.23. Preliminary project costs for flood protection levee design, permitting, and construction.
- Figure 3.24. Adaptation pathway for the Corte Madera Marsh and Railroad Right-of-Way.
- Figure 4.1. Corte Madera's hillside neighborhoods; Christmas Tree Hill (A), Chapman Hill (B), and Granada Hill (C).
- Figure 4.2. Proposed infrastructure improvements on Christmas Tree Hill and Chapman Hill.
- Figure 4.3. Proposed infrastructure improvements on Granada Hill.
- Figure 5.1. Suitable areas within Corte Madera for green infrastructure (permeable pavement, vegetated swales, or bioretention).



The Town of Corte Madera is surrounded by scenic and idyllic natural beauty and nestled between the baylands of the Corte Madera Marsh – which include one of the oldest and least disturbed marshes in the Bay – and Mount Tamalpais – a forested reserve that provides unique biodiversity and supplies water for the region. Hillside and shoreline neighborhoods are connected by a thriving economic core anchored by the historic old town area and two shopping malls that service the region. Home to many long-term residents, Corte Maderans care deeply about their community and its future.

The town's way of life and future is at risk from climate change. Much of the hillside region of the town is located in the Wildland Urban Interface (WUI), and recent wildfire seasons have demonstrated that no areas are truly safe from wildfires and smoke. Catastrophic wildfires can occur in the region at any time, putting the health, safety, homes, and infrastructure of the community at risk. The shoreline neighborhoods, built post-WWII on bay fill, are subsiding, facing rising sea levels, and experiencing king-tide and storm-drive flooding. Extreme rainfall from atmospheric rivers dump water faster than stormwater systems can direct it to the Bay. Town-wide, extreme heat – especially when combined with public safety power shut-offs – poses risks to older residents and those with chronic health conditions. As the climate changes, all of these risks are increasing.

Yet, despite these risks, Corte Madera is also presented with opportunity; the Town is on the forefront of adaptation planning in Marin county and the North Bay region. It is building on the extensive foundation of climate change science and risk studies and is taking action based on best practices. A town that faces real and serious challenges in ensuring the near- and long-term health and safety of all its community members, it recognizes that for the next generation of Corte Maderans, the community will likely look very different from today.

Building climate resilience is a process and not the outcome of a single project. It will require ongoing collaborations, partnerships, and investment.

The time for taking action is now! Thinking holistically about the risks of climate change and the opportunities for action is critical if the Town and the region are going to develop solutions that meet the scale of the challenge. Corte Maderans, Town Staff, and the Town Council all know this and have begun discussing, understanding, planning for, and taking action to adapt to climate change. By being proactive and investing now, the Town can help build community resilience and support the physical, mental, and social health of its residents. This goes beyond being prepared for future events and includes making investments in the everyday quality of life for residents, non-resident workers, and visitors. If done well, this effort can also provide extensive environmental and economic benefits to the community.

This plan serves as a roadmap for the Town and community; it lays out the steps necessary to address ever increasing climate challenges. However, the completion of this plan does not mean the Town has accomplished its resilience goals. **Building climate resilience is a process and not the outcome of a single project. It will require ongoing collaborations, partnerships, and investment.** By bringing people together, breaking down silos between sectors and departments, thinking creatively and boldly about solutions, and prioritizing near-term collaboration and early investments, the Town can continue to be a regional leader in developing and implementing flexible, robust, and equitable climate adaptation strategies.

CORTE MADERA IN CONTEXT

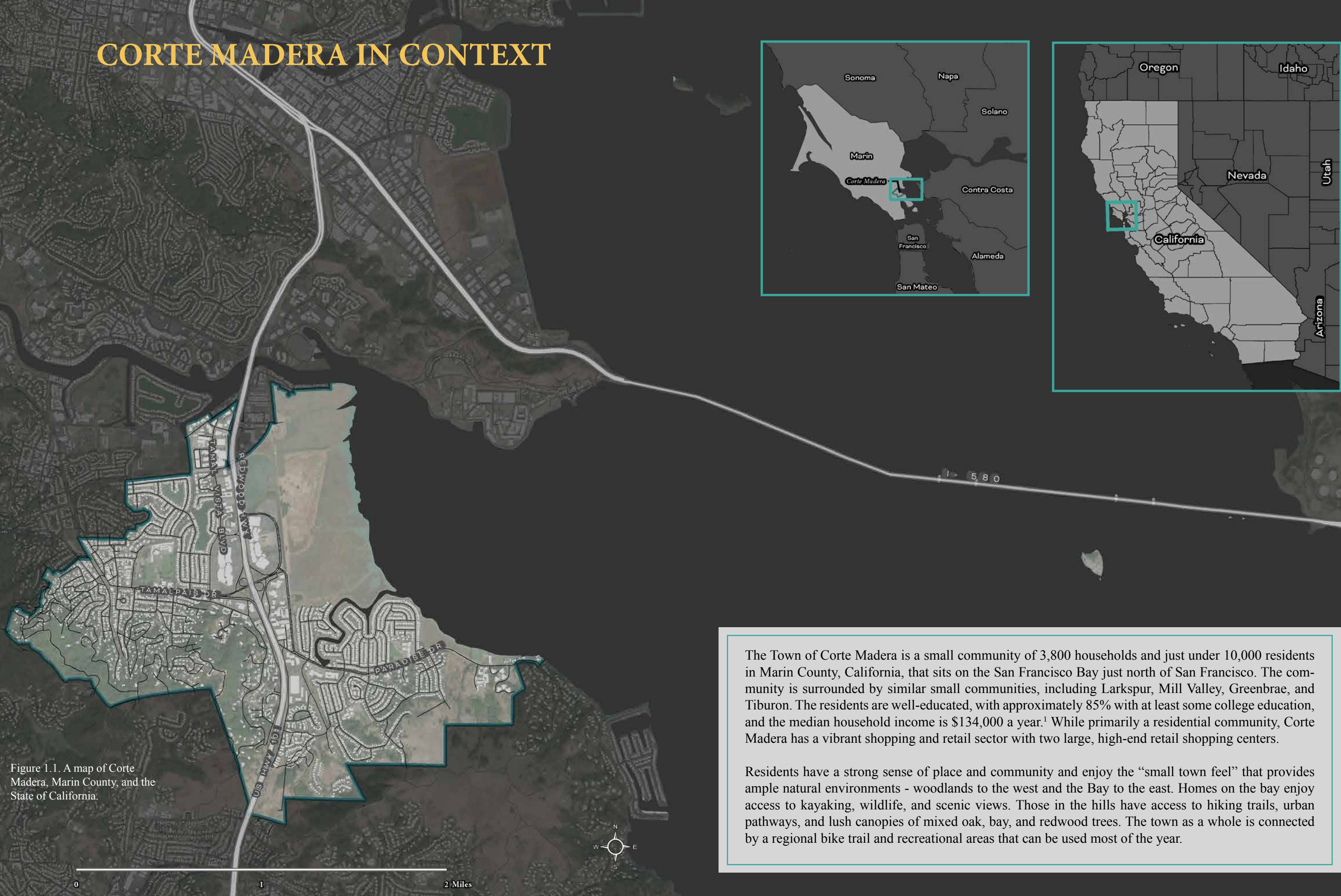

Figure 1.1. A map of Corte Madera, Marin County, and the State of California.

The Town of Corte Madera is a small community of 3,800 households and just under 10,000 residents in Marin County, California, that sits on the San Francisco Bay just north of San Francisco. The community is surrounded by similar small communities, including Larkspur, Mill Valley, Greenbrae, and Tiburon. The residents are well-educated, with approximately 85% with at least some college education, and the median household income is \$134,000 a year.¹ While primarily a residential community, Corte Madera has a vibrant shopping and retail sector with two large, high-end retail shopping centers.

Residents have a strong sense of place and community and enjoy the “small town feel” that provides ample natural environments - woodlands to the west and the Bay to the east. Homes on the bay enjoy access to kayaking, wildlife, and scenic views. Those in the hills have access to hiking trails, urban pathways, and lush canopies of mixed oak, bay, and redwood trees. The town as a whole is connected by a regional bike trail and recreational areas that can be used most of the year.



Figure 1.2. Early development in Cortez Madera in 1926. © Cortez Madera Memories

The history of development within the town is also a story of increasing climate vulnerability. Early development in the area occurred at the base of the hills on the drier, upland edges of the marsh. The railroad at the time roughly corresponds to what is now Highway 101, crossing the marshes and Cortez Madera Creek. With the development of the Golden Gate Bridge and the post-WWII housing boom, there was a dramatic increase in homes and businesses in Cortez Madera within the next few decades. Without strategic planning or strong policies in place to address this increased level of development, homes were built in the hillsides to accommodate the town's growth. As Mariner Cove and Marina Village were developed east of the railroad, levees were constructed to protect low-lying areas from flooding, and in other areas, fill was placed to raise the ground elevation under homes (see Figure 1.3).



Figure 1.3. Low-fill (A) and high-level fill development (B) progression from the 1960's in Cortez Madera. © Cortez Madera Memories

DEVELOPMENT IN CORTEZ MADERA

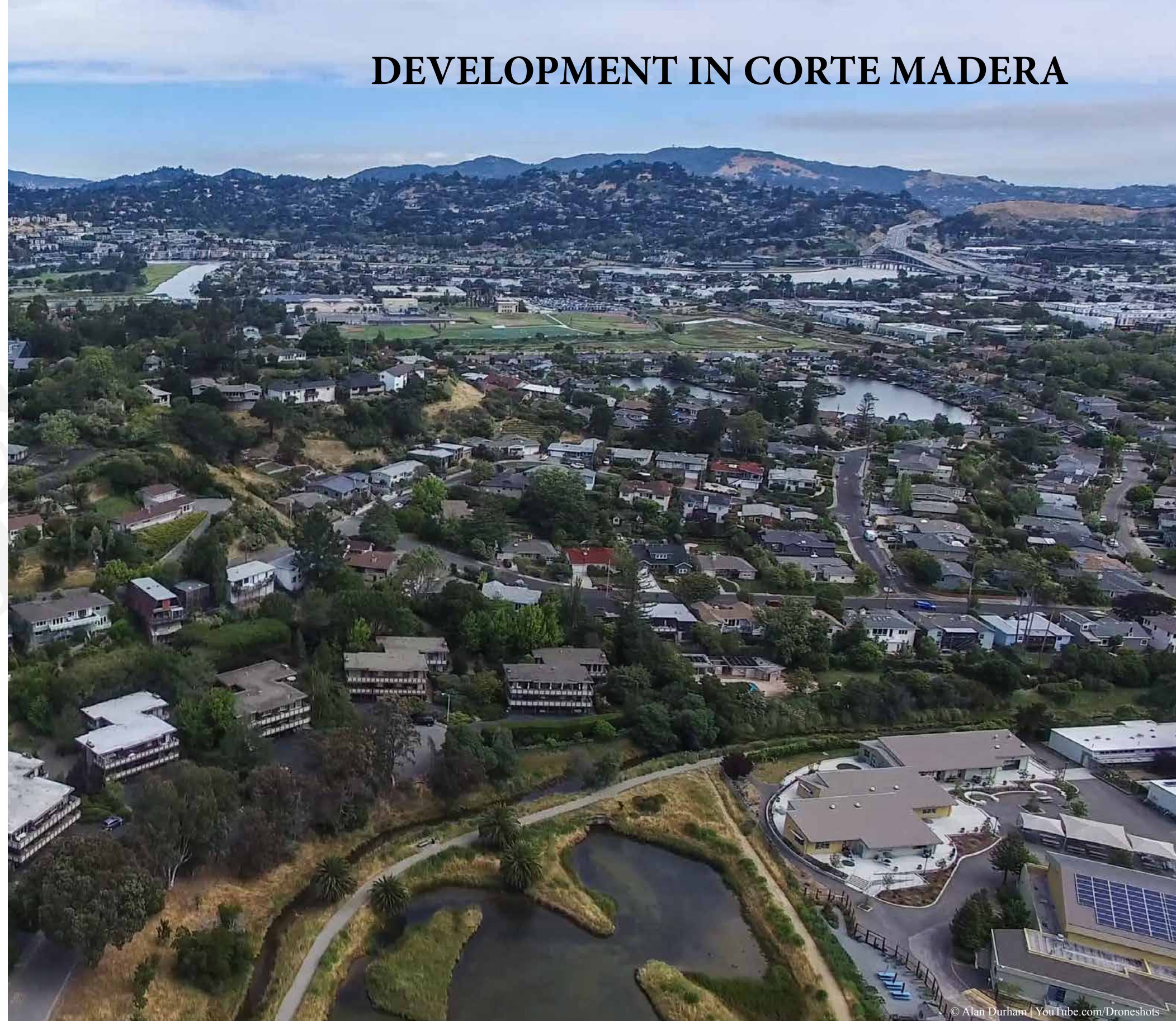

Today, Cortez Madera has a mix of neighborhoods both built up and into the hillsides and out along the bay. A legacy of preserved marshland is a significant asset for the community. Highway 101 passes through the center of the town, making it a key piece in the regional transportation network and providing easy access to the two shopping centers.



1

planning for climate change

THE PLAN

Plan Phases

The Corte Madera Climate Change Adaptation and Resilience Plan was completed over two years (January 2019 - February 2021). Over the course of those 25 months, Town staff, the Resilience Advisory Group (RAC), and community members progressed through five key phases to develop the adaptation roadmap and actions highlighted in this plan.



Figure 1.4 - The five phases of the Corte Madera Adaptation and Resilience Plan.

Plan Vision

One Town. One Region. Resilient Together.

The project envisions “**One Town. One Region. Resilient Together.**” The Town, surrounding communities, Marin County, and the entire region must work together to enhance resilience and successfully adapt to climate change. Climate change exposures and risks do not respect jurisdictional boundaries. Similarly, people move between home, work, and leisure, many traversing Highway 101, which connects the Town to the North Bay and San Francisco. Building resilience requires incorporating the interconnectedness of the region in local planning and action.

Guiding Principles

Resilience planning requires a broad-based, holistic, and interdisciplinary perspective that considers people, the environment, and local infrastructure. The health, vitality, and wellbeing of the community depends on all of these components seamlessly working together. Five guiding principles have helped inform the development of this plan.

- **Now is the time for action.** While investments likely need to be phased in over time, it is critical to start taking action now. This plan provides the details on an adaptation program for the next five years and a roadmap for the next few decades that can be used to guide the Town’s actions and investments to support resilience.
- **Collaboration, networking, and learning are critical.** Adaptation is a process, not the outcome of a single project. Bringing together local and regional partners to develop solutions and learn from each other is critical to success. Having the right partners at the table will help design, fund, and implement solutions. This paradigm of collaboration permeates all aspects of this plan and the work that the Town intends to do over the next three decades.
- **Investments in resilience should be cost effective and provide multiple benefits.** When balancing where and when to make investments, the Town will identify benefits provided by each investment. Ideally, these investments will be cost effective, and the values provided will be commensurate with the scale of the challenge and will enhance the resilience of the community as a whole, especially for those who have been historically marginalized and have fewer resources.
- **Flexible, nature-based solutions are preferred.** It is important to explore nature-based or hybrid adaptation solutions that both provide multiple benefits and can adapt (or be adapted) to changing conditions over time. These flexible solutions can be more cost-effective and scalable over time.
- **Taking the Long View.** Continued investments, attention, and commitment to the vision, goals, and actions of this plan are needed to achieve success. This plan should be reviewed and updated regularly, especially when conditions and scientific understanding changes or improves. The Corte Madera of the future may not look like it does today, and decisions made now will determine whether the Town will remain a vibrant and thriving community.



GOAL 1

Protect the health, safety, and wellbeing of all town residents, visitors, and workers by focusing on preparedness and prevention.

Protecting the health and safety of people, both now and in the future, includes supporting risk reduction, emergency preparedness, response, recovery, and improvements to everyday quality of life.



GOAL 2

Incorporate resilience and equity into all of the Town's plans, policies, and projects.

Historically disadvantaged and underserved front-line members of the community experience the first and worst impacts of climate change. To successfully build resilience, actions must meet the needs of community members who face the greatest climate impacts with the least resources. Normalizing consideration of both climate change and equity in Town planning and actions is a crucial component of enhancing resilience.



GOAL 3

Increase community awareness about the urgent need to take action and prepare for climate change.

An informed community can help create and implement strategic and effective solutions.



GOAL 4

Bring the community, neighboring towns, and the region together to plan and fund actions to build resilience.

Multi-jurisdictional collaboration requires effort and attention. This collaboration is critical to the success of the broader resilience initiatives.

Plan Goals

Building on the Guiding Principles, the goals were established through community engagement and refined over the course of the project to reflect the Town's values and interests.

PLANNING APPROACH

Local and State Policy Context

The Town of Corte Madera's goals and efforts to address climate change align closely with various state adaptation and resilience policies. First and foremost, the Town of Corte Madera's Adaptation Plan aligns with the Executive Order (EO) B-30-15, a major backdrop for state and regional adaptation planning.² EO B-30-15 directs and provides guidance to state agencies to integrate climate change into all planning and investment, including accounting for current and future climate conditions in infrastructure investment and suggests local governments develop climate plans that address climate change adaptation.³ California state law also requires each municipality and county to adopt a comprehensive, long-term general plan to guide development, and in October 2015, the governor signed Senate Bill 379 into law, which went into effect January 1, 2017. SB 379 adds a safety element requirement to the general plan that addresses "climate adaptation and resiliency strategies" and states that the updates must include a "set of adaptation and resilience goals, policies, and objectives" and "a set of feasible implementation measures designed to carry out the goals, policies, and objectives."⁴ The safety element of the Town's current general plan (2009) will need to be on before January 1st, 2022.^{5,6} Through this Adaptation Plan, the town meets SB 379 requirements in advance of that date by housing the prescribed climate adaptation and resilience elements in a stand alone document that can be incorporated into the next general plan.⁷

This Climate Adaptation Plan should be incorporated into the Town's next general plan by reference to satisfy the requirements of Senate Bill 379.

The plan also aligns with the mandates of Senate Bill (SB) 264, which brings together state and local government, non-profit and private sector practitioners, scientists, and community leaders to develop and help coordinate holistic strategies that better prepare California for the impacts of a changing climate at state, regional, and local levels.^{8,9} The Adaptation Plan also bolsters the Town's adherence SB 1035 which, similar to SB 379, requires local cities and counties include and regularly update climate adaptation and resilience and new information relating to flood and fire hazards in the housing elements of their general plans including a vulnerability assessment, a set of goals, policies, and objectives for the protection of the community, and a set of feasible implementation strategies.¹⁰ Drafted in 2015 and updated every 8 years, Corte Madera's current housing element addresses planning through the year 2023 and is drafted to be consistent with all other elements of the 2009 general plan.¹¹

Further, the Adaptation Plan's goals align with SB 2800 which provides support for climate-smart infrastructure. Through July 1, 2020, this policy required state agencies to take into account the current and future impacts of climate change when planning, designing, building, operating, maintaining, and investing in state infrastructure.^{12,13} It also aligns with SB 1, an infrastructure bill that includes provisions for improving environmental outcomes for state infrastructure projects.¹⁴

Several state policies provide guidance on how local jurisdictions can continually consider all aspects of adaptation and resilience, including social equity and environmental justice. A unique state policy, California's SB 1000 requires environmental justice to be addressed in local government planning, and the California Environmental Justice Alliance (CEJA) and PlaceWorks' "SB 1000 Implementation Toolkit" provides best practices for promoting meaningful community engagement.^{15,16}

Building on Regional and County Assessments and Planning

This plan has been informed by broader regional and county-wide work on climate change. It expands upon the Town's involvement in the Marin Bay Waterfront Adaptation Vulnerability Evaluation (BayWAVE). BayWAVE is a major collaborative effort among county, cities, special districts, and others to provide a detailed vulnerability assessment that evaluates the extent of impacted assets and work with local cities and towns to plan implementation of adaptation strategies.¹⁷ As a part of the BayWAVE project, the Town of Corte Madera also participated in drafting the Adaptation Land Use Planning: Guidance for Marin County Local Governments which explored cross-jurisdictional sea level rise impacts and appropriate adaptation land use planning approaches that could be considered by multiple local governments and unincorporated areas.¹⁸ This plan also aligns with the update to the Marin County Multi-jurisdictional Local Hazard Mitigation Plan that includes all of the towns and cities within Marin County.¹⁹

The Plan's focus on the vulnerability and adaptive capacity of local transportation systems complements the Marin County Department of Public Works' Highway 1 Corridor project that examines adaptation options addressing sea level rise and current flooding at Highway 1 and on the Mill Valley-Sausalito Trail in Southern Marin. It also complements Caltrans and North Bay partner's State Route (SR) 37 Corridor Plan that proactively identifies possible adaptation opportunities for transportation networks and natural ecosystems for the SR 37 corridor.^{20,21}

For more detailed information on adaptation projects happening in the Bay area, check out the Bay Area Climate Adaptation Network (BayCAN) website where you can learn about the hundreds of projects and programs being spearheaded by BayCAN members to address sea level rise, wildfires, extreme heat, drought, and other climate impacts.²²

Regional Collaboration

The complex nature of land jurisdiction and ownership in and around Corte Madera highlights the need to focus on collaborative approaches to monitoring, implementing, and evaluating any and all adaptation work. Often-times, different areas are governed by overlapping regulatory jurisdictions and require coordination for project planning, permitting, and development.

Below is a list of agencies and municipalities who will likely need to be consulted or involved in future adaptation planning:

- Larkspur
- Mill Valley
- Greenbrae
- Sonoma-Marin Rail Transit (SMART) District
- San Francisco Bay Conservation and Development Commission (BCDC)
- Marin Audubon Society
- Transport Authority of Marin (TAM)
- Golden Gate Bridge, Highway, and Transportation District (GGBHTD)
- California Department of Fish and Wildlife (CDFW)
- Association of Bay Area Governments (ABAG)
- Marin County Parks and Open Space
- Ross Valley Watershed District
- San Francisco Bay Regional Water Quality Control Board
- United States Army Corps of Engineers (USACE)
- National Marine Fisheries Service (NMFS)

Stakeholder Engagement Process

Stakeholder engagement was a central component of developing the Town’s Climate Adaptation Plan, and participants included a range of the municipal departments, local and regional organizations, environmental stakeholder groups, businesses, and homeowners. There were three levels of engagement:

- Community-wide activities appropriate for all members of the general public and other stakeholders;
- Partner meetings designed to gather and vet ideas with special interest groups and invested stakeholders such as CalTrans and the County of Marin; and, a
- Representative community and technical advisory committee with individuals from the Town, businesses, the school district, and county and regional agencies known as the Resilience Advisory Committee (RAC).

The Town developed an outreach and engagement plan to ensure the broadest possible level of participation in the planning process. The Outreach Plan outlined a range of activities and timeframe for stakeholder engagement activities. To help increase engagement, the Town offered multiple methods of feedback and learning opportunities for community members. It should be noted that the COVID-19 pandemic significantly impacted these planned activities, and all engagement after March of 2020 was held virtually. The process graphic below illustrates the general timeline and type of activities that were held. In all, there were over 1,000 various touches with the community.

- **Community-wide activities** included 4 workshops, two of which were online due to COVID-19, a project website (www.cortemaderaadapts.org), an online survey, newsletter and media outreach, a “storymap” detailing existing plans and projects (700+ views), and a community feedback survey.
- The **Resilience Advisory Committee** met six times throughout the project to review technical information and refine questions and materials designed to collect effective community feedback.
- The **Town Staff and Partners** met at several key junctions to inform the existing social, environmental, economic conditions within the town and provide feedback on and recommendations for potential projects and strategies.
- Town Staff presented to **Marin BayWAVE** and **Town of Corte Madera Flood Board**.
- The **Town Council** was updated on progress throughout the process.

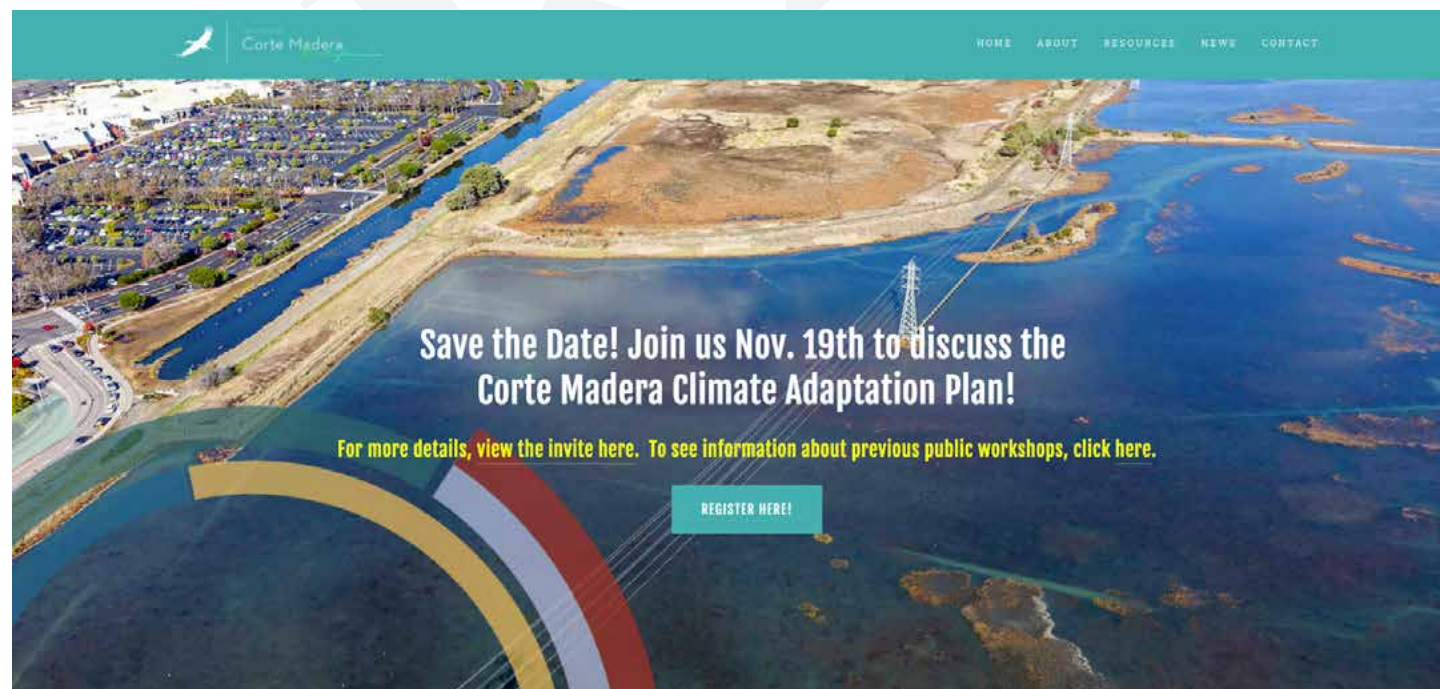

Figure 1.5 - A screenshot of the landing page on the Corte Madera Adapts website.

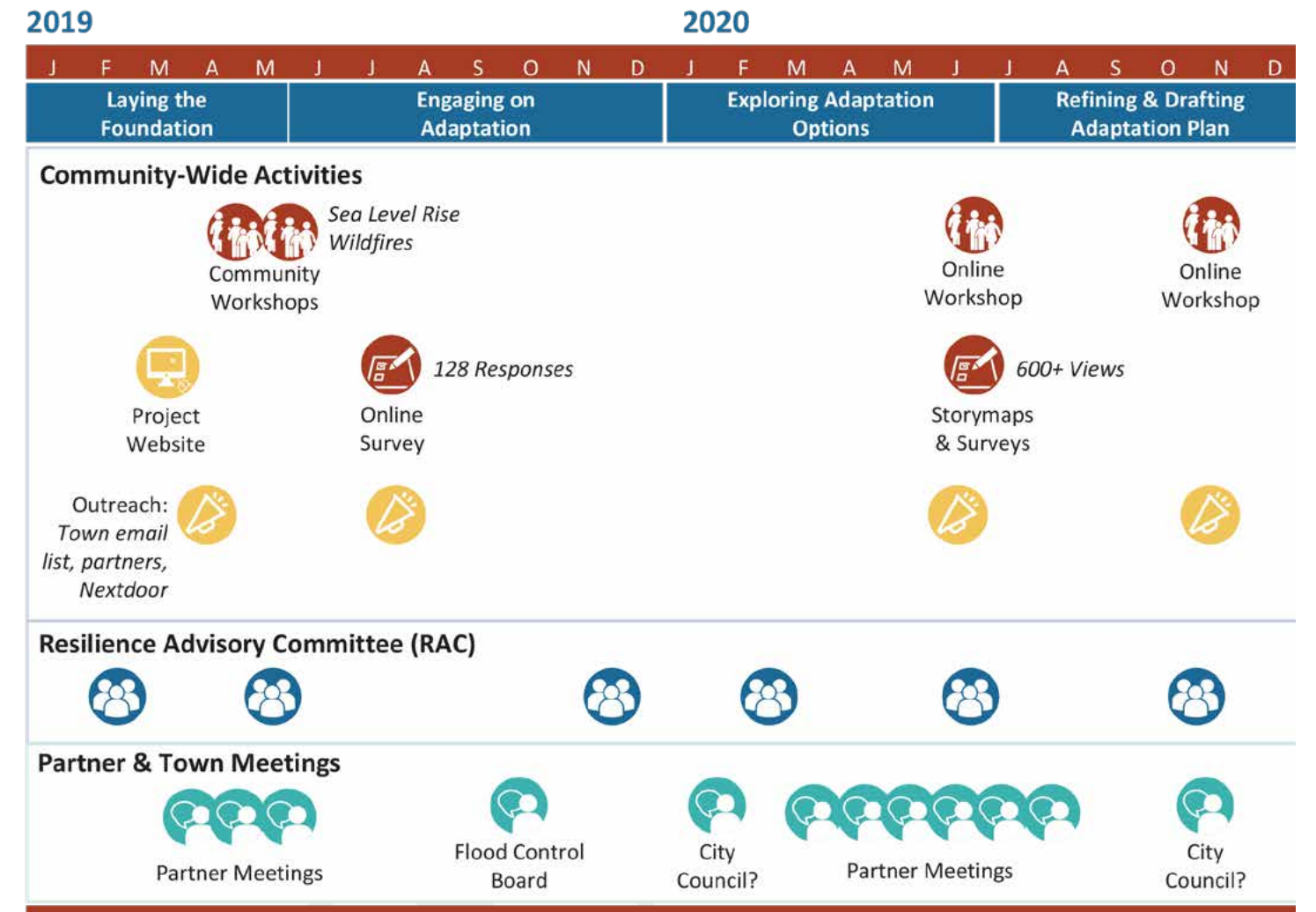

Figure 1.6 - A high-level overview of the stakeholder engagement activities and timeline for the Corte Madera Plan.



RAC meeting, February 2019 in the Town of Corte Madera council chambers. © Sascha Petersen

Understanding Town and Community Values

It is clear from conversations with the Resilience Advisory Committee and community members that Corte Madera is proud of their Town, love the “small town feel” and proximity to nature, and recognize their responsibility to be proactive in response to the climate crisis.

In the initial phase of this project, the project team conducted a survey²³ that received 128 responses. Of the total respondents, 72% were very concerned about climate change and 90% thought that climate change was either already affecting the community or would affect the community in the next 10 years. The top three concerns of respondents (identified by the number of people who ranked the issues as something they were “very concerned” or “concerned” about) were wildfires, sea level rise, and flooding from heavy rainfall. More than 50% of respondents felt that it was important to ensure that critical services and community members were resilient.

The Adaptation Library

The adaptation library serves as the foundation for the adaptation plan. In order to create a detailed adaptation program for the Town, actions relevant to local climate exposures were gathered from local, regional, state, national, and international plans as well as adaptation guidance documents, reports, and literature. These actions were then customized to fit Corte Madera’s needs and reviewed by Town staff and local experts. Actions in the library fall into three main categories of Policies, Programs and Projects.

- **Policies:** Locally-adopted regulations, rules and procedures can provide a foundation for a more resilient town. Policies are generally vetted through the Town Council, and require layers of approval before they can be implemented.
- **Programs:** The Town and its partners can develop, maintain, and implement a range of programs that can bring the community together, solidify a commitment to resilience, and offer the critical human component to fighting climate crises.
- **Projects:** Some of the Town’s most critical adaptation solutions will require changes to the physical environment or infrastructure. Often these efforts take more time and investment from the Town and regional partners.

Much like how multiple cords braided together create a stronger rope, braiding programs, policies, and projects together creates a stronger, longer-lasting, and more effective effort to build resilience (see Figure 1.7).



Figure 1.7 - A graphic representing how Policies, Programs, and Projects can be braided together to strengthen the Town’s efforts to build resilience.

Evaluating Adaptation Actions

The evaluation process used to identify high priority actions is based on the United States Agency for International Development (USAID) framework for evaluating adaptation options.²⁴ Figure 1.8 illustrates the evaluation process, different screening “tiers,” and possible outcomes. The Tier 1 screening focuses on a quick assessment of cost, feasibility, and effectiveness of the adaptation options being considered in light of the Town’s goals and needs. Actions that are not discarded based on this screening are reviewed in more depth and rated across three evaluation criteria: effectiveness, efficiency, and feasibility in Tier 2. Actions that score well across all three criteria are particularly relevant and a great fit for the Town. These actions are “expedited” and moved to the final customized library. Adaptation actions, or groups of actions, that need additional detailed evaluation or further comparison are passed through the Tier 3 screening process. This detailed analysis focuses on initial cost estimates, feasibility in specified locations, and the effectiveness of selected alternative investments.

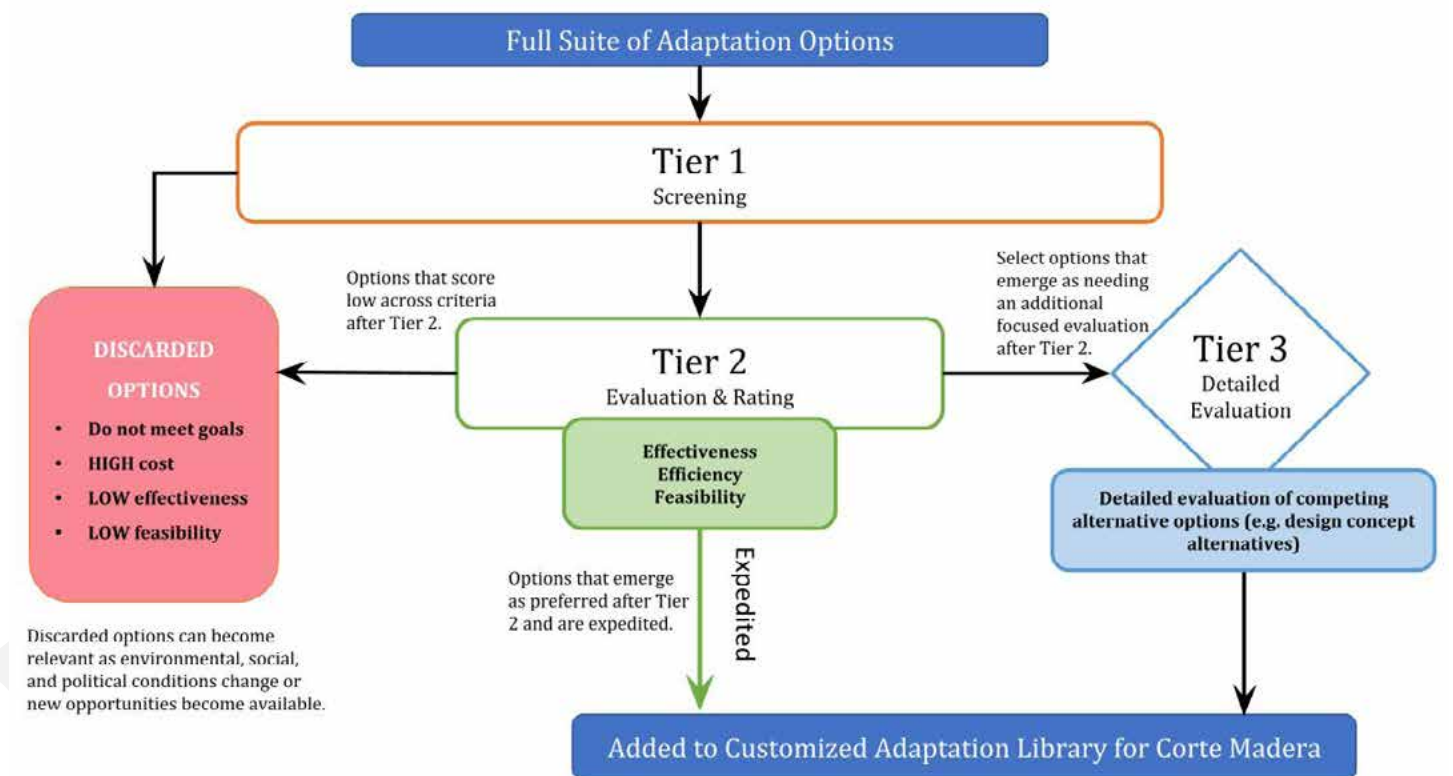

Figure 1.8. This figure illustrates the evaluation process for adaptation actions through Tier 1, Tier 2, and possibly Tier 3 screening.

Evaluation Criteria

In the Tier 2 screening process, each action was scored 1-5 for each of the three main criteria to determine relative rankings for individual actions. These criteria were selected based on the Town's input, published literature, State-wide adaptation and resilience efforts, and leading examples of resilience work in other parts of the world.^{25,26}

Effectiveness: *The extent to which the action achieves the desired outcomes.* The criterion considers how well the actions limits the short- and long-term impacts of climate change, the ability of the action to help meet the Town's goals, how well it prepares the town for the future, and whether it is commensurate with the exposure and the need.

Efficiency: *The extent to which the action makes efficient use of resources including funding, expertise, and staff time.* This criterion considers whether the direct, indirect, and external costs of implementing the action are balanced by the community, social, environmental, and economic benefits and whether it is equitable to all residents.

Feasibility: *The extent to which the action can successfully be implemented.* This criterion considers whether an action can actually be implemented and whether there is the current specific institutional, technical, community, and political setting and characteristics to be successful.

Adaptation Pathways Approach to Planning

Planning for climate change requires a shift in traditional planning approaches and requires the consideration of multiple possible outcomes and pathways to reach them. The adaptation pathway approach to planning can help local governments plan for multiple potential futures with differing environmental, social, and economic conditions. Additionally, the pathways approach helps address uncertainty by exploring the robustness, flexibility, and feasibility of various adaptation alternatives across multiple temporal and spatial scales and environmental conditions. Details on the specific adaptation pathways created for Mariner Cove & Marina Village as well as the Marsh and Railroad Right of Way can be found in the Shoreline section starting on pg. 54.

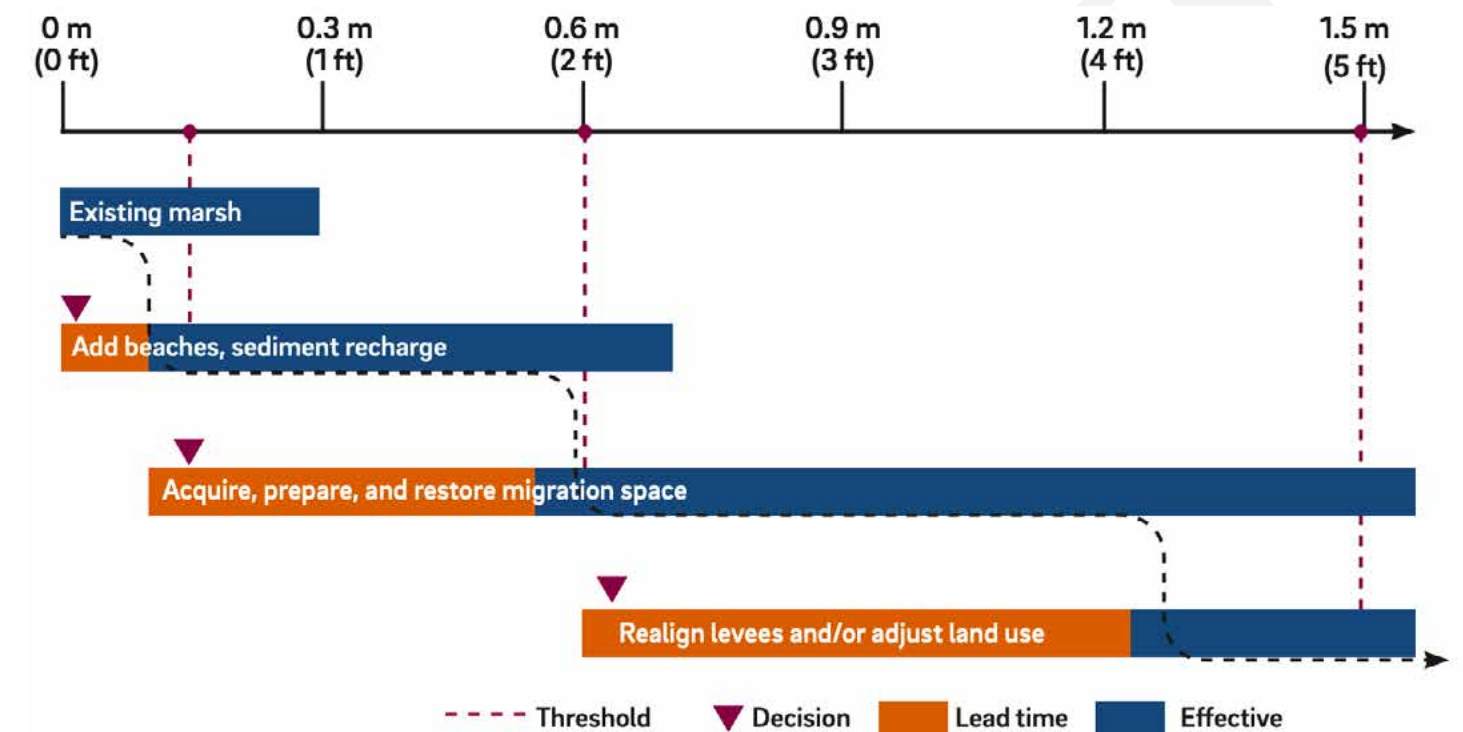

Figure 1.9. This graphic depicts an adaptation pathway approach to planning, which includes the conceptual phasing of actions with certain triggers (SLR in this example) rather than by a chronological timeline. Illustration from SF Bay Shoreline Adaptation Atlas (SFEI & SPUR, 2019).

The timeframe for planning and implementing different adaptation strategies varies greatly across strategies and locations. For example, the time to plan, permit, design, and build a levee takes much longer than it does to implement a change in building code or municipal ordinance. While some adaptation actions highlighted in the plan can stand alone, many of them are most effective when implemented concurrently with other actions. Some actions are contingent on particular decisions and are only effective if implemented before or after other actions. It can be important to identify “triggers” and “thresholds” associated with certain pathways or individual actions that can determine when a policy or project will become ineffective. Certain actions may only be effective for a discrete period of time or until particular environmental conditions are met or exceeded. For example, a levee may protect infrastructure until a particular amount of sea level rise, at which point it may be overtopped during a 100-year storm event.

The main function of the adaptation pathway approach is to develop strategies that are robust for the most likely future scenarios and/or can be modified or adjusted at key junctures in the future. It is essential to identify in advance how these changes would be implemented and when these changes would need to occur.²⁷ This approach can help the Town plan for, prioritize, and stagger investment.

Strategic Planning in Corte Madera

Adaptation and resilience planning in Corte Madera requires a long-term, cross-sectoral, and multi-layered approach. While some actions will need to be taken in specific locations, many others will need to be implemented with the whole community in mind. The subsequent sections of the report focus on specific climate exposures that are particularly relevant to the hillside, shoreline, and central Corte Madera focus areas of the town. These location-hazard pairs (hillside-wildfire, shoreline-coastal flooding, and central-inland flooding) allow for detailed consideration of the exposures and concerns specific to each area. The Town as a whole faces an interrelated mixture of climate exposures (see pages 22-35 for more information), therefore the full suite of adaptation actions in the following actions were chosen to address specific hazards more broadly, and in some cases, help the Town address multiple hazards at the same time.

Adaptation actions highlighted in each focus area (see Figure 1.10 for the three focus areas) are nested within key pillars of action and are described in more detail in the respective sections of the plan.

Town-wide Actions (pages 36-53):

- 1) Health and Wellness
- 2) Emergency Preparedness
- 3) Resilient Infrastructure
- 4) Collaboration

Shoreline Actions (pages 54-95):

- 1) Protect
- 2) Accommodate
- 3) Retreat

Hillside Actions (pages 96-121):

- 1) Evacuation
- 2) Wildfire Mitigation
- 3) Protection
- 4) Education

Central Corte Madera Actions (pages 122-137):

- 1) Collaboration
- 2) Protection

The full suite of high priority actions is extensive, and only some actions can be featured in each section of the report. The featured actions highlighted in each focus area demonstrate the depth and breadth of types of actions the Town can take but are not the only important (or most immediate) actions. The full suite of actions and more detailed information on each action can be found in Appendix X and are referenced throughout the plan.

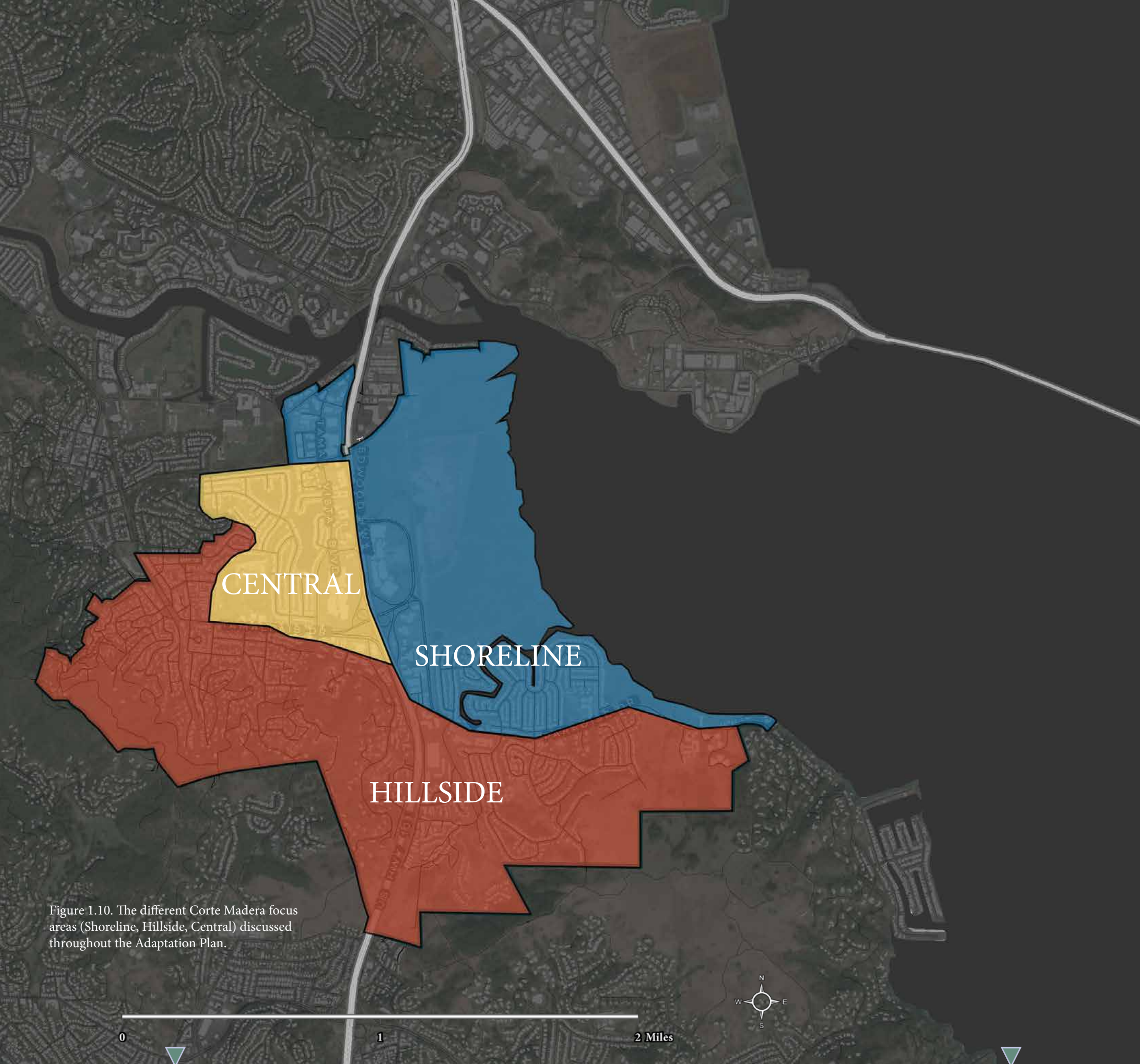

Figure 1.10. The different Corte Madera focus areas (Shoreline, Hillside, Central) discussed throughout the Adaptation Plan.

CLIMATE CHANGE AND CORTE MADERA

The Town of Corte Madera is already experiencing the effects of climate change, and projections indicate that these impacts will continue to worsen throughout the century. This increase in climate impacts poses significant immediate, medium-term, and long-term risks to the community's health, safety, economy, ecosystems, and infrastructure. The Bay Area's average annual maximum temperature has increased by 1.7 degrees Fahrenheit from 1950 to 2005 and will continue to increase creating a cascade of additional impacts that vary in severity, scale, certainty, and timing including the immediate and unpredictable risk of wildfire and the long-term and unavoidable sea level rise.²⁸

Climate vulnerability is dependent on three key factors: climate exposure, sensitivity, and adaptive capacity.^{29,30} The way these components interact determines the vulnerability of the people, assets, and ecosystems at risk.

- **Climate Exposure** - an extreme weather event or changing climate condition that can adversely affect people, livelihoods, species, ecosystems, environmental functions, services, resources, infrastructure and economic, social, and cultural assets.
- **Sensitivity** - the degree to which one of these components is affected by a climate exposure.
- **Adaptive Capacity** - the ability to adjust to potential impacts, take advantage of opportunities, and respond to climate exposures.
- **Vulnerability** - the degree to which something is susceptible to the adverse effects of climate change.

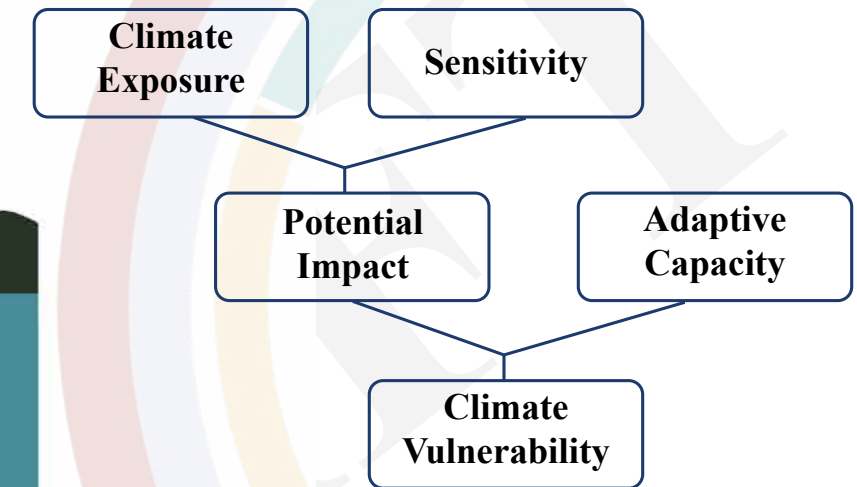
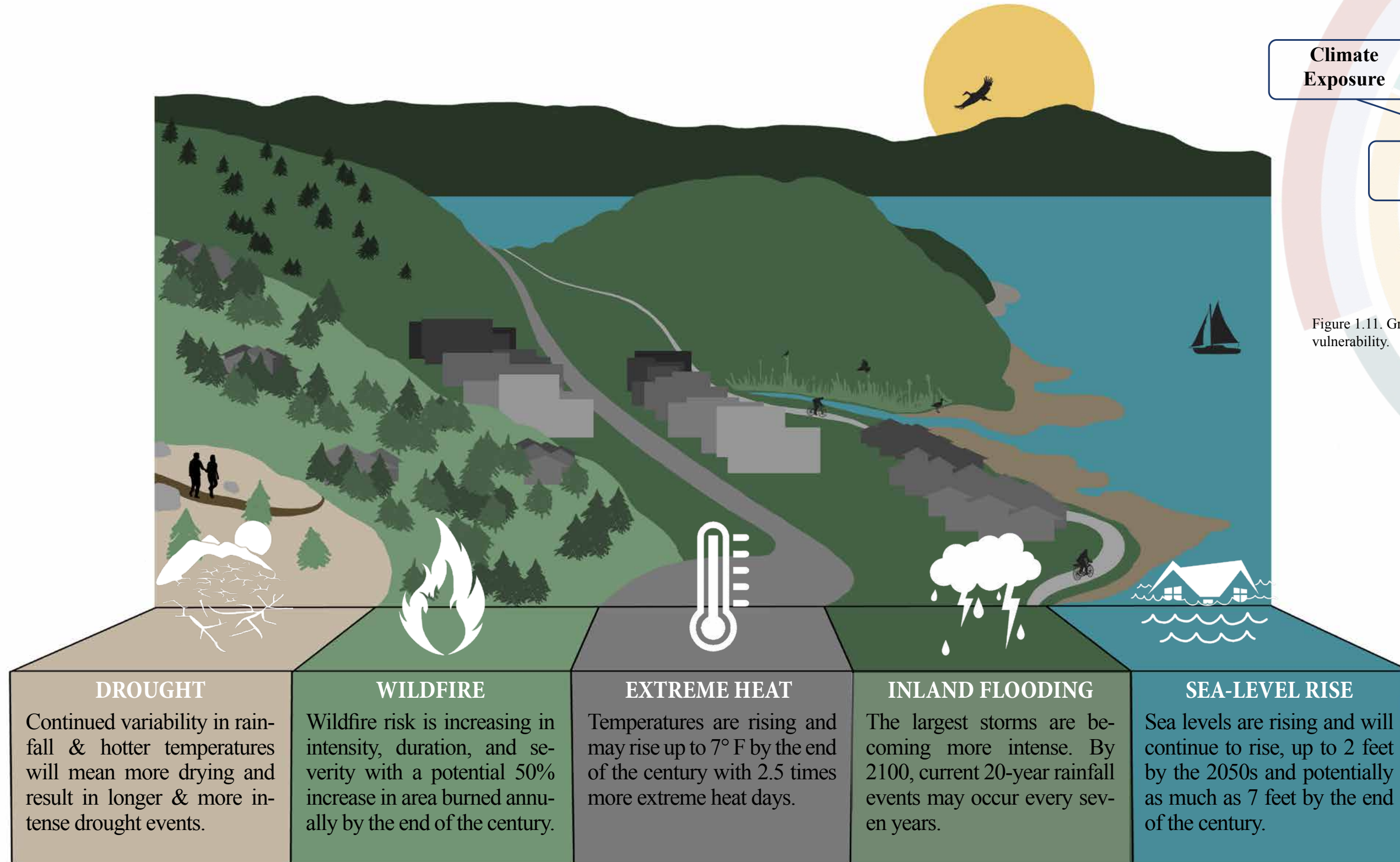

Figure 1.11. Graphic representation of the components of climate vulnerability.

Figure 1.12. Climate exposures summary for Corte Madera. Climate projections are based on the "business-as-usual" scenario (RCP 8.5).

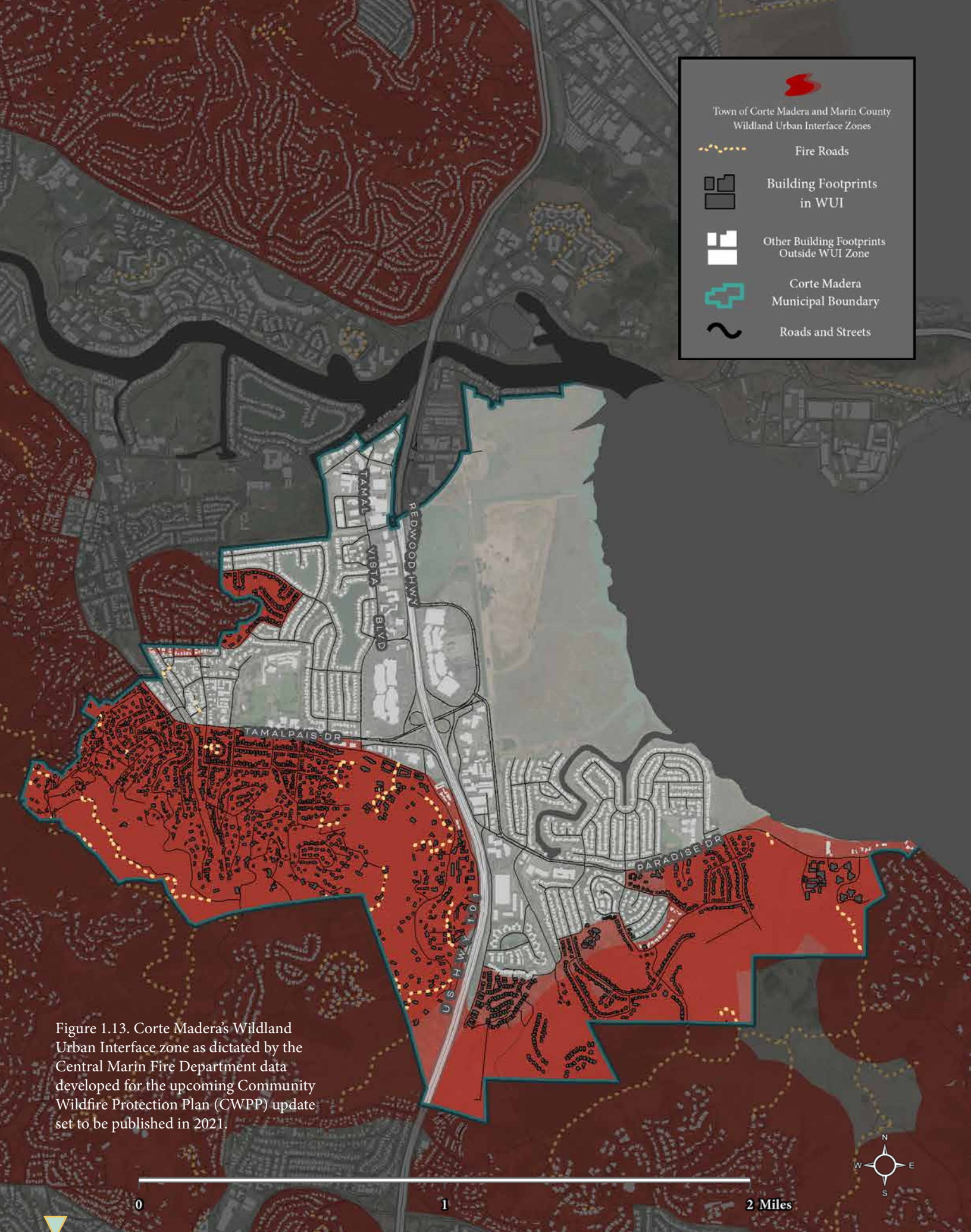

Figure 1.13. Cortes Madera's Wildland Urban Interface zone as dictated by the Central Marin Fire Department data developed for the upcoming Community Wildfire Protection Plan (CWPP) update set to be published in 2021.

Wildfire

In the past few decades, there has been a significant increase in the number of wildfire ignitions, acres burned, and harmful impacts to humans and ecosystems in California.³¹ Fires are becoming hotter, more severe, and more deadly.³² Recent studies suggest that climate change has rendered the concept of a “fire season” in California obsolete — major wildfires can happen at any time throughout the year and areas previously considered to be low-risk can experience major wildfires. A 2019 study³³ showed that, due to changes in the North Pacific jet stream, the correlation between winter rainfall and the severity of the fire season can no longer be made.³⁴ In addition, according to the California Climate Assessment, the average area burned statewide could increase 77% by 2100 if greenhouse emissions continue to rise.³⁵

Wildfire risk in Cortes Madera is significant due to several important factors: its unique climatic, topographic, and geologic attributes; ongoing longer and more

severe droughts; current and historical fire-suppression policy in California; County-level environmental policies that support vegetation growth in Marin County;³⁶ population growth in the Wildland Urban Interface (WUI); and, the exacerbation of the frequency, intensity, and severity of wildfires across California due to climate change.³⁷ Wildfires are also exacerbated by factors such as a reduction in annual snowpack, decreasing water supply, and rising temperatures across the region. A wildfire in the Cortes Madera community would put lives at risk and likely destroy homes and other infrastructure. Additional adverse impacts to the Town include poor to hazardous air quality, public safety power shutoffs (PSPS), and economic impacts from reduced retail visits. Research shows that there is a limited projected increase in the fire risk for Cortes Madera until 2050 but a large increase in fire risk between 2050 and 2085. In addition to hotter and drier conditions, offshore winds (especially in the fall) drive even more dangerous and persistent wildfire conditions.



Sea Level Rise

There is no doubt that over time sea level rise (SLR) will greatly impact the lives of Corte Maderans. Without action, daily high tides will eventually inundate major thoroughfares, schools, retirement communities, private homes, shopping areas, bike paths, protected wetland areas, and stormwater detention ponds. Increases in bay water levels will also intensify wave action on levees and marsh edges, speeding up the rate of erosion. Erosion of the marsh edge will reduce the width of marshes and result in the loss of wetland habitat and reduction in wave attenuation.³⁸ Eventually, rising seas will overtop the Bay levees causing significant damage and disruption to homes and infrastructure. The relative sea level rise (the amount of sea level rise relative to a fixed point on land) varies due to differential rates of sediment compaction, marsh accretion, and tectonic movement. Much of the Corte Madera shoreline infrastructure is settling because it was built on Bay fill over very deep bay mud that is compacting; this is causing land subsidence and accelerating the pace of relative sea level rise for neighborhoods such as Mariner Cove and Marina Village.³⁹ With rising seas, what used to be a 1% annual chance of a storm-driven flood event (100-year storm) has the potential to become the daily high tide water levels by the 2060s. Coastal flooding is determined by the water level above today's mean higher high water (MHHW), and is the sum of mean sea level, sea level rise, tides, and storm surges (which can be as much as 3 feet). A specific water surface elevation can be reached by combinations of sea level rise and extreme water level events. The sea level in the San Francisco Bay Area has risen eight inches in the past century and could rise up to 70 more inches by the end of the century (see Figure 1.14).⁴⁰

Sea level rise projections are probabilistic, meaning that for each scenario, a set of probabilities describe the likelihood that sea level will meet or exceed a particular amount of sea level rise within a given time frame. Selecting what level of sea level rise to plan for is generally done based on risk tolerance. The larger the potential consequences from a flooding or overtopping event, the more risk averse the planners should be and the more they should consider lower likelihood (but higher magnitude) events (i.e. 0.5%) in planning and design. Where the potential impacts of flooding are less serious, planners can be less risk averse and use a lower amounts of sea level rise for planning. The graph provides a summary of low risk aversion (orange line - 17% chance per year) and medium-high risk aversion (blue line - 0.5% chance per year) scenarios for sea level rise through the end of the century.

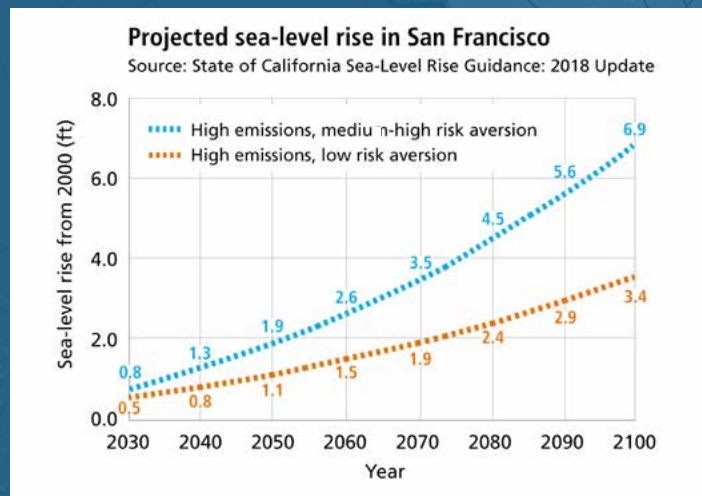

Figure 1.14. San Francisco Bay Area sea level rise projections.



Figure 1.15. Flood inundation map of Corte Madera depicting a water inundation scenario of three feet above mean higher high water (MHHW).





Impacts of Sea Level Rise on Groundwater

Groundwater levels in Corte Madera fluctuate over time due to variations in rainfall and water levels in the Bay, nearby lagoons, and channels. Groundwater is not pumped for potable water within the Town limits, and when groundwater levels are high, the ground becomes saturated and groundwater seepage can enter foundations, causing property damage.⁴¹ Saline conditions or salt water intrusion can further complicate problems from groundwater seepage, impacting buried infrastructure and vegetation. Groundwater seepage is a common occurrence in the residential bayside area, and many residents do not have sump pumps to remove standing water from around their houses. How sea level rise will affect groundwater seepage and salt water intrusion has not been widely assessed and planned for across the state, though pilot investigations have shown that local impacts can be severe in some communities including low-lying coastal areas.^{42,43}

Information on SLR-driven groundwater inundation in California is also limited by the lack of data on shallow coastal aquifers, which are not commonly studied because they are not suited for domestic or agricultural use. However, initial regional studies have found that Corte Madera is one of many urban areas around the Bay with very shallow coastal groundwater.^{44,45} In relatively permeable substrates, groundwater levels respond to tidal forcing.⁴⁶ Chronically-higher sea levels

may cause groundwater tables to rise even in areas with less-permeable substrates that do not show a tidal signal today. Discharge of rising groundwater to creeks, lagoons, and stormwater channels may reduce stormwater conveyance capacity and increase fluvial flood risk. But even before emergence flooding becomes an issue, groundwater at shallow and intermediate depths (e.g., <6 ft. depth) will present significant challenges to the maintenance of existing and new infrastructure (including foundations, basements, and buried utilities) and can affect human health due to mobilization of buried contaminants.⁴⁷

Engineering approaches to mitigate flooding (e.g. levees) usually do not address groundwater inundation, so assessment of this risk is an essential step Corte Madera and neighboring communities should take to be able to plan for the full impacts of climate change.⁴⁸

When a levee is constructed, rising groundwater levels landward of the levee increase the level of pumping required to protect local infrastructure. As a consequence, pumping groundwater from former wetland soils can increase the rate of subsidence in already-subsiding areas. A localized groundwater monitoring program specifically focused on the shallow coastal aquifer will help the Town collect the data needed to develop adaptation plans that thoroughly address this threat.

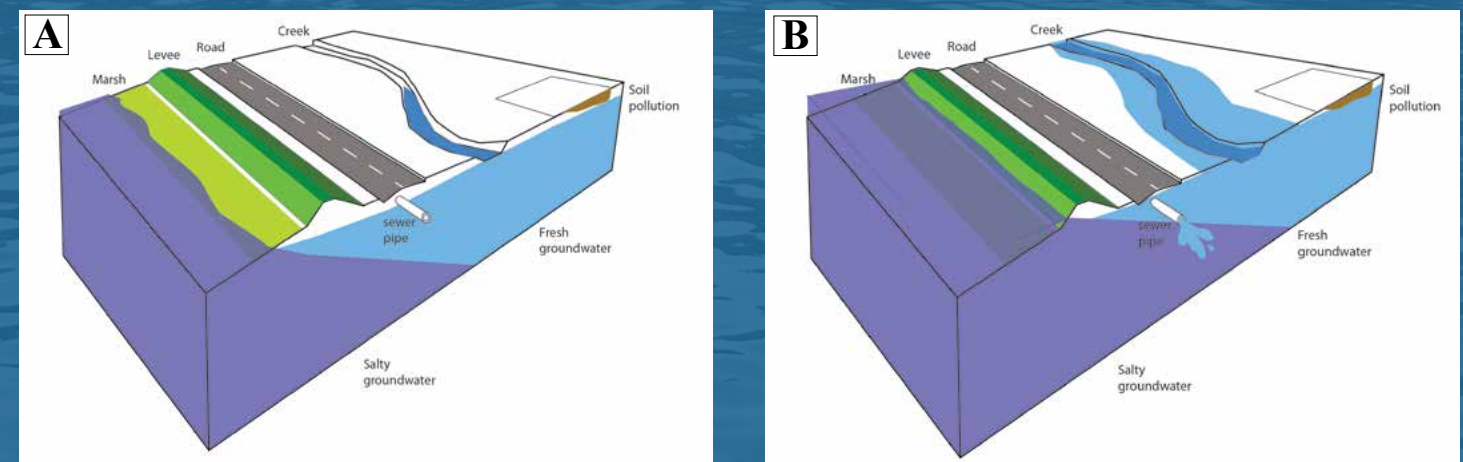

Figure 1.16. A schematic depicting groundwater inundation before (A) and after SLR and tidal forcing (B). Illustrations: Kristina Hill.



Extreme Heat

Projections for the San Francisco Bay area show an average annual warming of approximately 4.4 degrees Fahrenheit by mid-century, with an increase in up to 7.2 degrees Fahrenheit by the end of the century.⁴⁹ Extreme heat days in Corte Madera (temperatures above 94.7°F) historically averaged four days per year (1961-1990). If greenhouse gas emissions continue unchecked, there are projected to be 20 extreme heat days a year by the end of the century.⁵⁰ Rising heat days are a substantial concern due to the lack of air conditioning in most homes in the Bay Area. Extreme heat events can greatly impact physical and mental health by exacerbating existing and underlying conditions and causing heat stress and stroke in generally healthy popula-

tions. These impacts can be particularly acute for the very young, the elderly, those without adequate access to cooling areas, individuals who work outdoors, and the unhoused. Extreme heat may also damage transportation infrastructure through pavement rutting and heave, warping railroad lines, and construction and maintenance challenges.⁵¹ The increased frequency of extreme heat events impact the frequency and severity of drought and wildfires; this cascade effect leads to an increase in energy consumption through higher demand for air conditioning, further adding to greenhouse gas (GHG) emissions, and could increase the number of PSPS events.



Drought

Droughts are projected to increase in duration and intensity across the state.⁵² The Marin Municipal Water District (MMWD) supplies Corte Madera and the eastern corridor of Marin County with surface water sourced from seven local reservoirs, augmented by supplies from the Sonoma County Water Agency (SCWA).⁵³ The water supply comes from local runoff and the Russian River. Historically, during periods of extreme drought, MMWD has been able to successfully meet water demands through a combination of rationing, conservation, and additional supply from SCWA.⁵⁴ However,

more pervasive and sustained drought periods will likely limit the ability of MMWD to meet demands. Droughts also reduce the amount of water available to fight wildfires and increase the exposure of residents to extreme heat events, flash flooding, and degraded water quality. Further, increasingly intense and longer periods of droughts can stress natural systems, including the trees that cover the Corte Madera hillside, creating opportunities for disease, infestation, and drier, wildfire-prone landscapes.



A composite image of two images through the Corte Madera marsh, taken 5 months apart. © Roger Johnson, Flickr.com.



Inland Flooding

Increasingly intense and frequent extreme precipitation events,⁵⁵ altered drainage patterns, and increased development with impermeable surfaces are likely to increase the frequency and intensity of inland flooding in Corte Madera. This is not a surprise to residents as larger storm events coupled with king tide events already cause extensive inundation and the temporary closure of major streets. Additional factors that affect flooding in Corte Madera include fluvial hydrology, precipitation, tides, sea level rise, sedimentation, and

land subsidence. Inland flooding is exacerbated when the Town's experience simultaneous high tides and severe storms or a heavy amount of upland watershed runoff. Heavy precipitation events, such as atmospheric rivers,⁵⁶ not only cause inland flooding in low lying areas, but also can lead to landslides and other damaging events. Some uncertainty remains in future projections for total precipitation; however, understanding the general trend in increased heavy precipitation events is important for decision making and planning purposes.



Flooding from an extreme precipitation event on Casa Buena drive on February 12, 2019 in central Corte Madera. © Leslie Regan

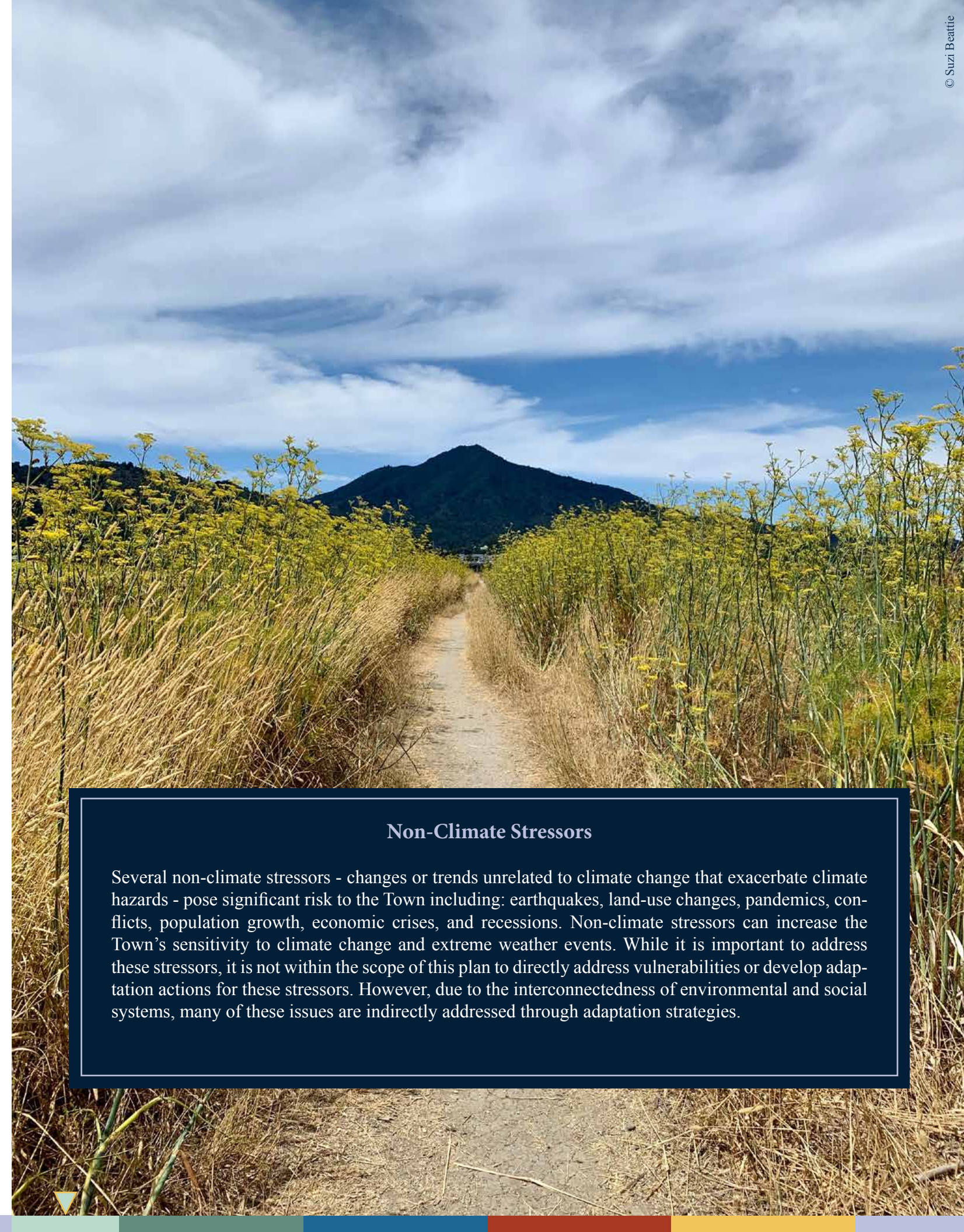

Non-Climate Stressors

Several non-climate stressors - changes or trends unrelated to climate change that exacerbate climate hazards - pose significant risk to the Town including: earthquakes, land-use changes, pandemics, conflicts, population growth, economic crises, and recessions. Non-climate stressors can increase the Town's sensitivity to climate change and extreme weather events. While it is important to address these stressors, it is not within the scope of this plan to directly address vulnerabilities or develop adaptation actions for these stressors. However, due to the interconnectedness of environmental and social systems, many of these issues are indirectly addressed through adaptation strategies.

The Town, Climate Change, and Public Health

Climate change will affect all Corte Maderans. Extreme weather events, such as heat waves and flooding, and wildfires can affect the direct health and safety of residents and visitors. Disruptions to the transportation network from flooding or wildfire events limit the ability of people to evacuate and move away from danger, decrease access to hospitals and medical care facilities, and reduce the ability of emergency first responders to protect residents. Indirect effects, such as degraded air quality from regional wildfire smoke and ash also threaten the health and wellness of Corte Maderans. Climate-related events that require people to remain indoors more often can also affect mental health and strain social relationships that bind families and the community.^{57,58} While all residents of Corte Madera are at risk, these changes can be particularly impactful for frontline community members that have chronic health conditions or other underlying disease burdens.

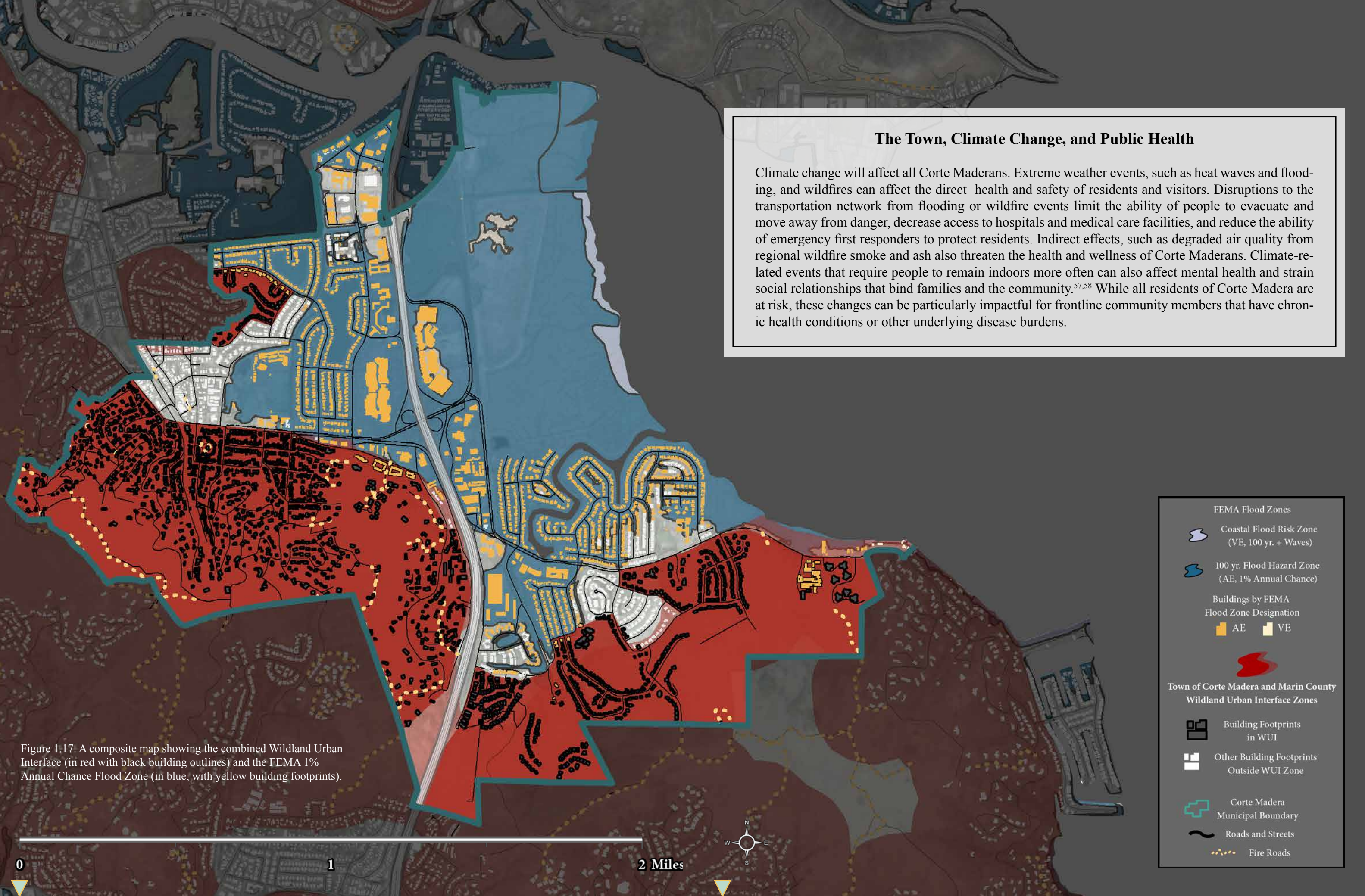
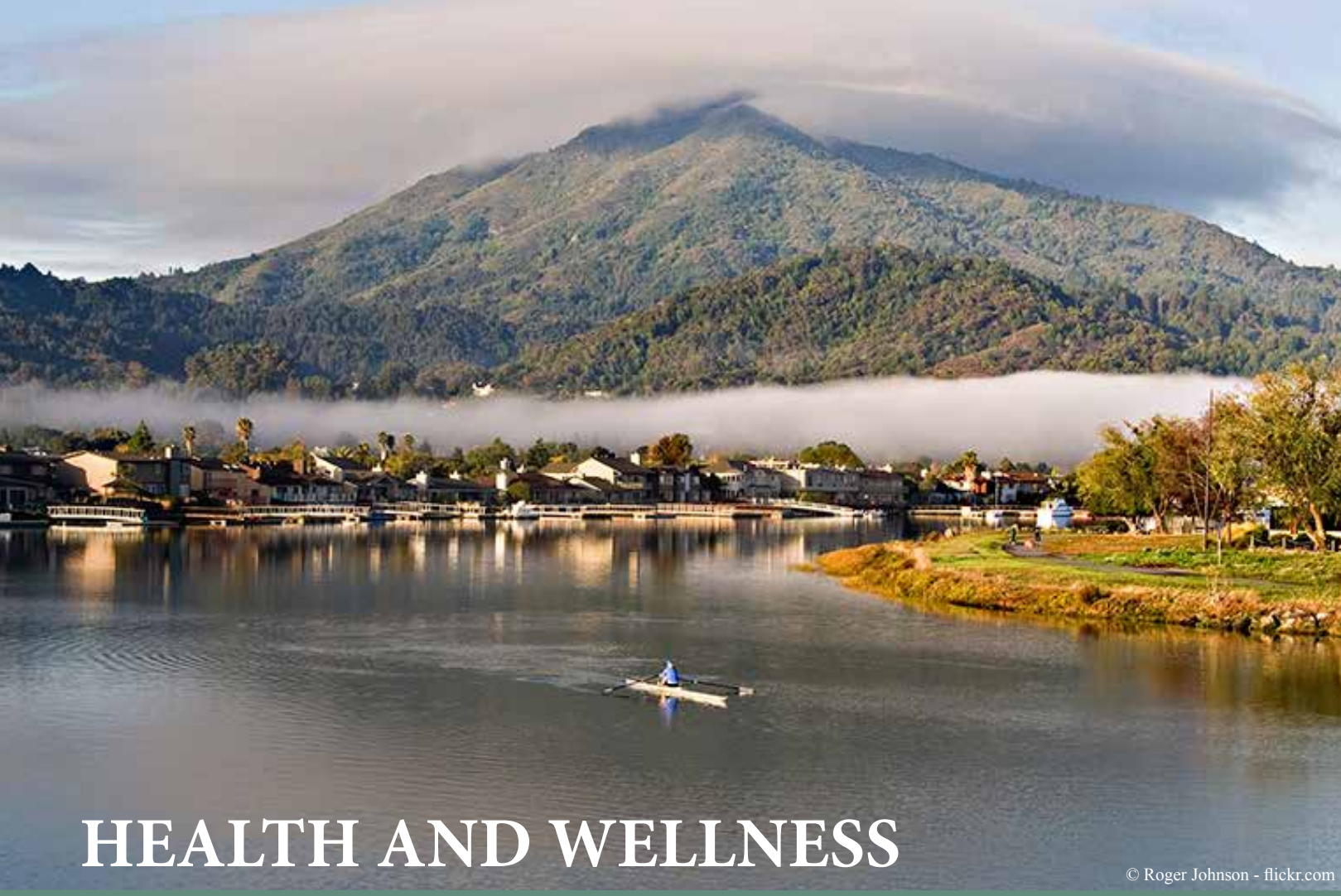

Figure 1.17. A composite map showing the combined Wildland Urban Interface (in red with black building outlines) and the FEMA 1% Annual Chance Flood Zone (in blue, with yellow building footprints).



town-wide





HEALTH AND WELLNESS

© Roger Johnson - flickr.com

The events of the last few summers have shown that summer heat waves and smoke from regional wildfires, can affect everyone in the community. Dense wildfire smoke, which directly impacts physical health, mental health, and limits the ability of all Corte Maderans to go outside (*100 AQI or above for sensitive populations, and 150 AQI and above for healthy adults*),⁵⁹ has become a regular occurrence. While extreme heat events are uncommon in Corte Madera, hot summer days and warm nights are projected to become more frequent and last longer. Wildfires not only affect the health and safety of residents but have lasting mental health impacts related to the trauma of leaving ones' home or the loss of possessions and income. Both the direct and indirect impacts from heat and wildfire smoke can be

particularly damaging to the health of frontline community members such as older adults, youth, those with chronic health conditions, outdoor workers, and the unhoused.⁶⁰ The Public Safety Power Shutoff (PSPS) program by PG&E is designed to reduce the likelihood of wildfire ignitions due to downed power lines or other system malfunctions during red flag warning days (days with high temperatures, high winds, and low humidity) has created lasting power outages throughout the region, county, and Town. Experiences from these events have shown that power outages that last more than a day affect the functionality of critical infrastructure in Corte Madera, including cell-towers, traffic signals, sanitary district pump stations, and refrigeration.⁶¹



FEATURED ACTIONS: HEALTH AND WELLNESS

Coordinate with community organizations, especially environmental justice, LatinX, and other community organizations to identify gaps in frontline community resilience planning and further engage frontline community members in wildfire risk, evacuation, and resilience work.

Project
Lead: TBD

Collaborating with regional organizations dedicated to engaging and supporting frontline communities are key to building trust and ensuring the health, safety, and well-being of all residents.

Identify climate change-related mental health and trauma treatment measures to incorporate into existing town plans, trainings, programs, and policies.

Project
Lead: TBD

Extreme weather events can have significant impacts on mental health,⁶² and this connection is often challenging to integrate into regional planning efforts. Yet it is critical that this issue receives dedicated attention and resources. Example organizations include the Psychological First Aid (PFA), Skills for Psychological Recovery (SPR), or the Good Grief Network.



Develop and adopt a Green Infrastructure Plan with a focus on climate resilient tree species.

Project
Lead: TBD

A Green Infrastructure Plan would provide the framework for understanding, defining, and planning green infrastructure. Corte Madera's urban forest provides a number of services including detaining stormwater, absorbing air pollutants, and creating shade that cools sidewalks, streets, and buildings. Continuing to invest in green infrastructure, including climate-resilient tree species, will not only enhance resilience, but also add to resident well-being and quality of life.





Ensure all Town buildings have smoke and particulate filtration systems, especially dedicated emergency evacuation shelters and resilience hubs.

Project
Lead: TBD

Ensuring that buildings and resilience hubs in Corte Madera have effective smoke and particulate filtration systems is key to ensuring the health and well-being of residents, especially during an emergency. Additional actions include deploying low-cost particulate matter sensors in relevant Town locations that provide data for indoor and outdoor levels in real-time. Resilience hubs can also incorporate solar and battery storage systems to provide a reliable center for cooling, water, power, and communications during power outages and reduce utility costs during daily operations.

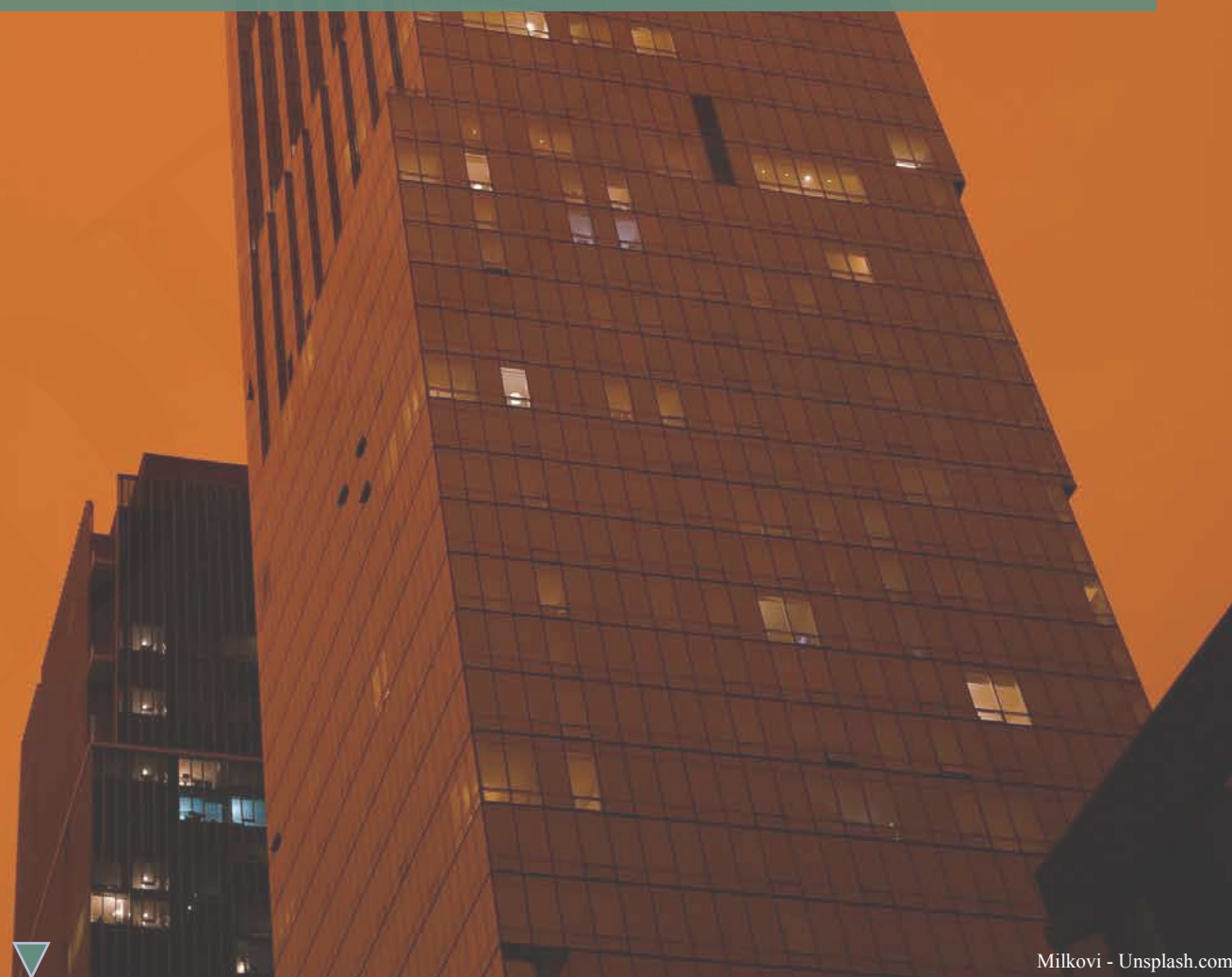

Green Infrastructure and LID

Green infrastructure relies on plants, soils and natural systems to manage rainfall by absorbing, delaying, and/or treating stormwater.^{63,64} Green infrastructure solutions are multi-beneficial in that they can help reduce pollution from runoff, prepare for extended droughts by retaining water, reduce temperatures in urban areas during hot weather, improve air quality, lower building energy demands, protect coastal areas, and reduce energy spent on managing water.⁶⁵ Additionally, green infrastructure in urban areas has been proven to improve mental health and wellbeing.⁶⁶ Similarly, low impact development (LID) is a method of building design and community development with the intention of minimizing and mitigating climate impacts like flooding or urban heat.⁶⁷

Green infrastructure can be woven into the community from small-scale site specific elements to larger-scale elements across the entire watershed. Examples include permeable pavement, trees and other deep-rooted plants, rainwater catchment systems, and bioswales. Swales and bioretention areas can be integrated into landscaped areas, medians and parking strips. Permeable pavements can provide volume reduction and water quality treatment without taking up additional space.⁶⁸ The Environmental Protection Agency (EPA) has a plethora of resources, including a section on overcoming hurdles of Green Infrastructure implementation on its [website](#).

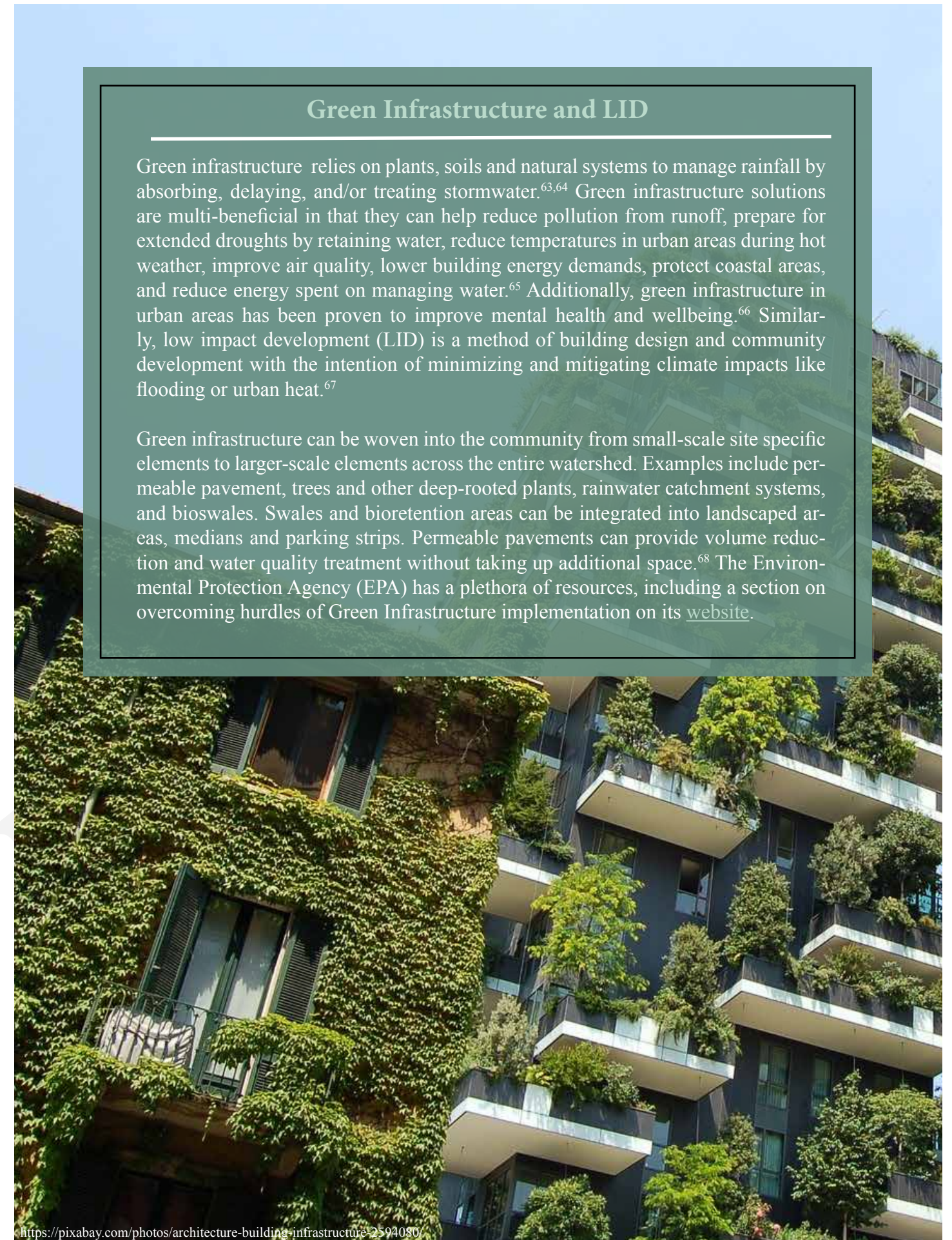

<https://pixabay.com/photos/architecture-building-infrastructure-2594080/>



EMERGENCY PREPAREDNESS

Emergency preparedness requires individual awareness, strong communication, and reliable sources of information available through multiple channels. In order to minimize the impact of potential disasters for community members, the Town plays an important role in making sure residents and visitors have the correct information about what to do and where to go in the event of a disaster. Individuals also have a responsibility in emergency preparedness, and should stay informed, prepare emergency kits, and otherwise take precautions to minimize risk to themselves and their families.

Reaching all Town residents with clear and up-to-date information in emergency situations remains one of the biggest challenges Corte Madera currently faces. For example, the Town currently relies on Alert Marin and Nixle which are free, opt-in emergency alert systems. Yet as of 2019, only around 10% of the county's residents had signed up to receive alerts.⁶⁹ Communication challenges are compounded by difficulties reaching residents who do not have internet service or those who lose power during a PSPS event or an emergency.

FIRESafe Marin currently has an agreement with all Marin municipalities (except Tiburon and Belvedere) to develop wildfire evacuation maps and plans to be published in 2020.

Future planning efforts should focus on regional connectivity and communication, engaging the right regional partners in Town evacuation planning, optimizing the Town and Counties evacuation protocols, and identifying key potential challenges in regional evacuations. For example, there have not been any regional evacuation-focused traffic studies done necessary to determine important details regarding regional choke points, the amount of time required to evacuate the entire Town, and other important details. In addition, several of the county's transit services and partner agencies are not adequately integrated into the emergency operations or chain of command, nor are they properly integrated into the Marin Emergency Radio Authority (MERA) communications system and therefore don't have an effective and efficient way of communicating with the public during an emergency.⁷⁰

Rethinking Evacuation Notification Systems in Corte Madera

Over the last several years, catastrophic and deadly wildfires have ignited critical reviews of inconsistent emergency management measures and notification systems across the State of California. Concerns have been focused on “gaping holes in the state’s county-controlled warning systems - a mix of services from multiple vendors, subscriber programs with low participation rates, outdated landline lists, and a federal cellphone alert system so imprecise some emergency managers are afraid to use it.”⁷¹ Some lawmakers have pushed for measures that would “override state privacy laws” to create automatic, mandatory, opt-out emergency notification systems. In addition, several counties (including Sonoma County) are improving the way they communicate with and engage non-English speaking residents and other frontline community members in emergencies.

Currently, the Town uses several key emergency notification systems to ensure that residents have the most pertinent and up-to-date information about emergency and evacuation measures including:

- **Alert Marin** - The single most important source for specific emergency and evacuation notifications in Marin County (i.e. shelter in place, flood or wildfire notices, house or neighborhood specific evacuation warnings and orders). Residents can sign up for this opt-in notification service from Alert Marin at www.alertmarin.org
- **Nixle** - A service used by regional agencies to send out informational notices about an issue in the community (i.e. Red Flag days, vehicle accidents, or road closures). Nixle notifications are sent to users by zip code, therefore has less specificity than Alert Marin. Residents can sign up for opt-in notifications from Nixle at www.nixle.com/
- **Social Media** - The Central Marin Fire Department and the Marin County Sheriff's office uses Twitter, Facebook, and NextDoor to relay pertinent information about evacuation, road closures, and resources. Residents can follow the County Sheriffs office on Twitter, Facebook, and NextDoor using the handle @marinsheriff and the County Fire Department at @marincountyfire
- **Local TV and Radio Stations** - Local media sources are often reliable sources of specific information regarding evacuation and wildfire preparedness.
- **Wireless Emergency Alerts (WEA)** - This notification service sends “push notifications” by text message to residents by zip-code who have a compatible cell phone and who sign up for the service. Notably, if power lines or cell towers are disrupted or damaged due to wildfire, these notifications may no longer work. Additional critiques across the State have pointed out inadequacies and distrust of the WEA system and have requested broad improvements.

All residents should review, understand, and complete the following checklist to ensure that they are prepared for an emergency evacuation in the case of a catastrophic wildfire. The full checklist and additional information about these systems can be found on the FIRESafe Marin website at <https://www.firesafemarin.org/evacuation> Broader town and county-wide discussions about the current emergency notification systems Corte Madera relies should focus on addressing gaps in planning and engagement as well as integrating emerging best practices from around the State. Guidelines from the State can be found [here](#). Overall, there are no silver bullet solutions for this complex problem. Yet, additional attention to, and continued collaboration with regional entities to improve these systems may save lives.



FEATURED ACTIONS: EMERGENCY PREPAREDNESS

Require that climate change is included in Town or multi-jurisdictional planning documents, policies, programs, and ordinances as they are reviewed or updated.

Policy and Project

Lead: TBD

Ensuring that all Town plans are consistent, reflect best available knowledge of regional climate projections, and support the Town's efforts to reduce climate change and extreme weather impacts is essential. It is also critical that updated climate projections are used to inform capital improvement projects (i.e. new or upgraded roads) which should meet design standards that incorporate flood risk, landslides, and sea level rise projections.

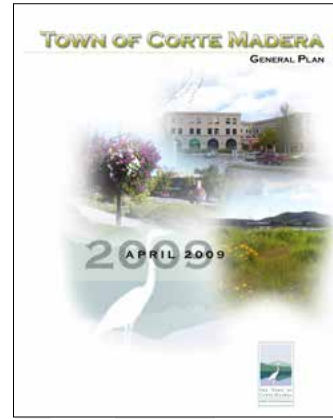

Figure 2.1 - The Corte Madera General Plan (2009).

Ensure all residents are able to access emergency and evacuation notices via multiple sources, including voice, text, siren, radio, and outdoor broadcasts.

Program

Lead: TBD

In the 2018 Camp Fire in Paradise, California, all communications went down for residents due to telecommunications infrastructure being destroyed in the fire. This disaster highlighted many flaws in an antiquated notification system that many communities (including Corte Madera) rely on. Recently, the California Public Utilities Commission ordered wireless communication service providers to develop resilience plans and investments in their networks (including generators that run 72 hours following an emergency) in order to make sure users have access to communications and notifications during an emergency.⁷⁵ The Town should also identify opportunities to increase engagement and subscription of Town residents to key evacuation notification systems (i.e. *Alert Marin*). This includes considering a mandatory alert notification system or creating an opt-out system.

Educate ALL community members about evacuation protocols, maps, and procedures for emergency preparedness and evacuation.

Program

Lead: Central Marin Fire Authority

The Town needs to more proactively identify and address gaps in their communication and messaging when it comes to evacuation. This includes consistent messaging around Alert Marin and the nationally recognized *Ready, Set, Go* program,⁷² participating in and integrating the regional collaboration and current evacuation mapping work into Town materials and presentations, coordinating with County evacuation notification partners (Central Marin Fire and Sheriff's Office) and working with FIRESafe Marin to make sure that residents have access to and are engaging in their wildfire preparedness and evacuation programs. This includes putting people on the ground in neighborhoods to engage with residents directly.⁷³ In 2018, the Central Marin Fire Authority conducted a public evacuation drill in which only 18% of residents participated. A recent report also indicated that residents in Marin County were presented with inconsistent information specific to wildfire preparedness and this message "failed to reach most citizens, especially parents of young children", prompting a call by the Marin County Civil Grand Jury to better educate, inform, and engage the public about emergency preparedness in the case of a catastrophic wildfire.⁷⁴

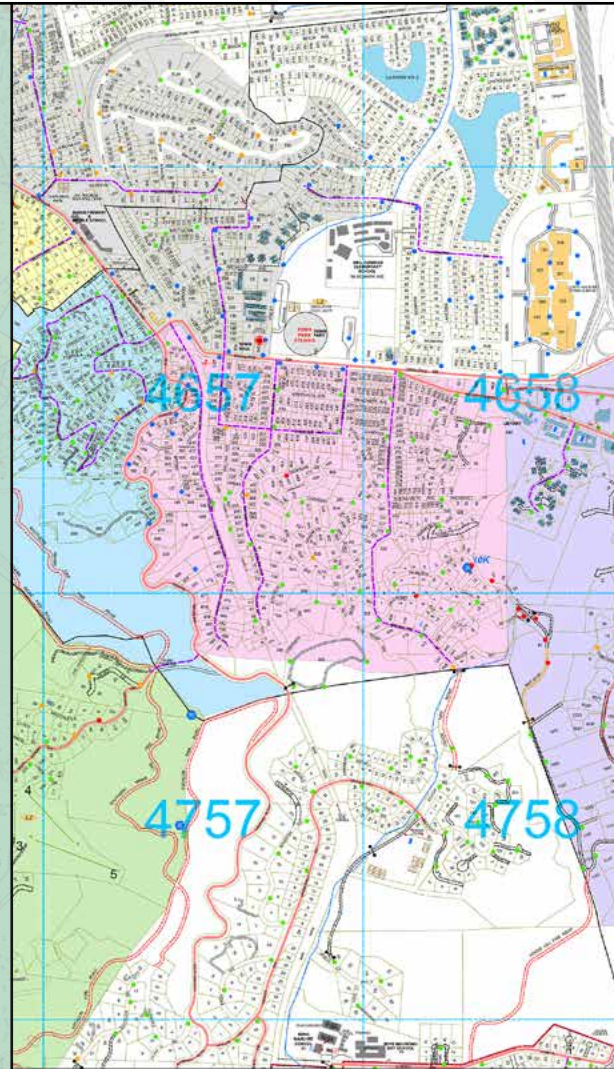

Figure 2.2 - The Corte Madera area featured in the Marin mutual threat zone plan evacuation zone maps.

Integrate protocols, systems, and planning best practices for managing the impacts of evacuation, emergency response, and health care during a global pandemic from federal emergency response agencies (i.e. Red Cross and FEMA).

Project

Lead: TBD

There is no denying that the COVID-19 pandemic has changed the way communities, schools, and organizations operate. It is unlikely to be the last such sweeping health crisis that changes how we deal with emergency response during a pandemic. Currently, new protocols are being written and tested by groups like FEMA and the Red Cross to address this issue, such as how best to protect evacuees and use hotels instead of communal shelters to house. These protocols incorporate the 5 C's - Communication, coordination, cooperation, collaboration, and connection, and ensure that we break down agency and jurisdictional silos and integrate public health planning into emergency operations. Corte Madera can learn from these experiences and should incorporate key findings and recommendations into its emergency plans and protocols.



Identify opportunities to enhance the capacity of community centers and school facilities to become Resilience Hubs, evacuation centers, cooling centers, and charging stations, during extreme heat or weather events.

Project
Lead: Corte Madera Public Works

The Town has applied for a grant to help make the new Town Hall expansion a Resilience Hub for the community. The building will be earthquake resistant, provide shelter for people during extreme weather events, provide resources and information for residents on emergency management and preparedness, power for public uses during power outages, and provide other public services.



Resilience Hubs in Corte Madera

Resilience Hubs are unique “community-serving facilities” that are emerging in cities across the country in order to support residents, enhance communication, and serve as a centralized location for distributing services before, during, and after a natural hazard. They use a physical space - a building and its surrounding infrastructure - to meet numerous goals, both physical and social. Resilience hubs can effectively improve emergency preparedness, reduce climate pollution, and enhance community resilience.⁷⁶ By retrofitting, or augmenting established, trusted, and community-managed facilities, Resilience Hubs also provide community members and decision-makers with an opportunity to work together on climate mitigation, adaptation, and equity efforts in a holistic way that also builds community resilience and community well-being.⁷⁷

Work by the Urban Sustainability Directors Network has brought this emerging practice to the forefront of adaptation and resilience efforts for leading communities across the country. Corte Madera knows first hand how wildfire smoke, power shutoffs, flood events, and extreme heat events can stress the Town’s infrastructure and its community members. Older adults, kids, those with disabilities, low-income residents, BIPOC (Black, Indigenous, and people of color), LGBTQ, English as a Second Language (ESL) communities, the unhoused, those who lack transportation, and those with chronic illnesses or specific ongoing medical needs are particularly at risk during natural hazards or extended periods without power. PG&E’s PSPS events,⁷⁸ or other extended periods without power, can limit the ability of residents to cook, work, complete schoolwork, or communicate with friends and family. Resilience Hubs should be designed by and built with the neighborhoods they serve in collaboration with local businesses, nonprofits, and others invested in community resilience and well-being. If done well, Resilience Hubs are co-designed with the neighborhoods they serve and effectively support at-risk community members. They also serve as a focal point for additional community investment, are managed by community members, and support and strengthen individual neighborhoods.

- **Buildings** - The best locations to house Resilience Hubs are trusted community locations in different neighborhoods across the Town such as the new Town Hall, Cove School, or Neil Commings Elementary. Idea buildings are safe, have solar energy storage or generator backup systems, are ADA accessible, have air-conditioning and heat, are earthquake resistant, are equipped with air filtration systems (in the case of extreme wildfire smoke), have kitchens, and provide enough space to shelter residents in case of an emergency are all important considerations. In addition, Hubs should be located in safe areas away from (or above) flood plains or high fire risk areas.
- **Emergency Needs** - Hubs should be able to supply needs during a crisis such as freshwater, food, ice, refrigeration, charging stations, and emergency medical supplies. Ideally, the hub could supply power for at least 72 hours via renewable sources and battery storage or generators. These energy systems can reduce the use of fossil fuels on normal days (and thus reduce GHG emissions) and support critical services during emergencies.
- **Supporting Activities** - These Hubs shouldn’t only be used in times of disaster. They can support community activities, after school programs, health screenings, or other important community functions. In addition, those amenities should be designed with the community/neighborhood to ensure that it meets the needs of its residents.
- **Social Cohesion** - Building on the long standing tradition and support of Neighborhood Response Groups, the Resilience Hubs can act as safe spaces for community members to gather, strengthen relationships, and foster an inclusive year-round community. These investments will pay off in times of emergency as neighbors continue to find opportunities to support each other.

Resilience Hubs in Action

The City of Los Angeles set the goal of creating Resilience Hubs in the City’s most vulnerable neighborhoods by 2028. Since setting that goal, the LA Regional Climate Collaborative and non-profits in the region have been further exploring this concept, holding webinars and discussions on how best to move forward and achieve this goal.



RESILIENT INFRASTRUCTURE

Throughout the community, people are generally reliant on personal vehicles and utilize a limited number of roadways. This leads to congestion throughout the transportation network, which is especially dangerous during an emergency. Where and how the Town's infrastructure is built will determine how well it can protect residents and accommodate or mitigate future climate and extreme weather impacts. Further, the Town does not own electricity, drinking water, or telecommunications infrastructure directly, but must work directly with those companies, agencies, and organizations to enhance the resilience of those systems.

This report discusses three types of infrastructure: critical facilities (clinics, fire and police stations, schools), residential and commercial buildings, and the multimodal transportation network.

Increased investment in transportation infrastructure and policies are needed to facilitate mobility throughout the town in both everyday life and an emergency. Such investments will create a more resilient transportation network and simultaneously support the Town's environmental, health, economic activity, and equity values and goals.



FEATURED ACTIONS: RESILIENT INFRASTRUCTURE

Work with regional utilities to enhance the preparedness, protection, and resilience of water, energy, and telecommunications infrastructure.

Project

Lead: Corte Madera Public Works

The infrastructure we rely on is far more than just our roads, ferries, trains, and planes. We rely on telecommunications, water, and energy systems, all of which have their own unique challenges and characteristics when it comes to climate resilience. Each partner operates differently, and each partner plays a key role in supporting the Town. For example, Corte Madera obtains its drinking water from the Marin Municipal Water District (MMWD) which services ~190,000 customers within 147 square miles along the eastern corridor of Marin County from seven local reservoirs.⁷⁹ If a fire were to happen in the hills North and West of the Town, silting, erosion, and landslides would inevitably impact the water quality throughout the watershed. In addition, there are areas of the Town in which there is minimal water supply (Casa Buena Drive) or no water mains at all constructed (Meadow Valley).⁸⁰

Invest in and expand bike infrastructure and e-bike policies and programs.

Program

Lead: Corte Madera Public Works

Corte Madera has a strong culture of outdoor recreation, including bicycling. While the hillside neighborhoods don't seem the most hospitable to bicycling, the rapid and accelerating adoption of e-bikes (bicycles with an electric assist motor) offers mobility choices that could prove crucial in emergencies while providing additional benefits. Corte Madera, should consider policies to support the use of e-bikes such as designating charging stations to subsidize adoption.

Explore a regional approach to meeting housing development goals that locates new housing areas within the County that are less vulnerable to climate hazards.

Program

Lead: Corte Madera Planning Department

See Climate, Housing, and Resilience section on pages 130-131 for more details.

Ensure that transit agencies are involved in the Town's evacuation preparedness planning, comprehensive safety protocols, and emergency command structure.

Project

Lead: Corte Madera Planning Department

Regional transit representatives are key partners in the chain of command responsible for planning and implementing emergency evacuation. According to the Marin County Civil Grand Jury Report on Wildfire Preparedness, Marin Transit is the only transit provider represented in the Marin Emergency Operations Center (EOC). In addition, key regional partners are not included in these discussions (including Golden Gate Transit emergency managers, SMART representatives, Whistlestop, Marin Airpporter and ferry operators). Proper communication and close collaboration would enable the County and Town to evacuate residents as quickly and as safely as possible.



Improve transportation network capacity with multimodal and local access improvements.

Project

Lead: Corte Madera Public Works

Rather than solely accommodating vehicles, the Town should cultivate strategies that increase community members' ability to regularly utilize pedestrian pathways, bikeways, and transit, including improving and expanding multimodal infrastructure. Specific policies and infrastructure improvements can be referenced on page 104. Lastly, the Town should also work with regional agencies to incorporate statewide and regional transportation goals and land use plans to produce a cohesive multimodal adaptation approach.

Improve transportation infrastructure to streamline traffic flow in case of an emergency evacuation.

Program

Lead: Corte Madera Public Works

This includes updating traffic control centers, solar powered signs, and optimizing merge conditions and signals that can operate reliably during PSPS and emergency events. Preserving and improving the transportation network will require time, resources, and planning. The Marin Wildfire Protection Authority (MWPA) will publish an evacuation study that will assess Town and County evacuation connections including a focus on transportation infrastructure, roadways, and traffic control centers in 2021. As appropriate, recommendations from this effort should be integrated into all existing local and county plans, including the General Plan, the Capital Improvement Plan, and the Hazard Mitigation Plan, among others.

While there is access to both the Larkspur Ferry Terminal and Sonoma-Marin Rail Transit (SMART), the town straddles US Highway 101 and most trips are made by car. Due to the town's sparse multimodal transportation network, people are reliant on personal vehicles and also funneled through a limited number of roadways. This leads to congestion throughout the network, which is especially dangerous during an emergency. In particular, the hillside neighborhoods have very limited connectivity within and between them and also lack multimodal connections. In some cases, the transportation network across the town is supplemented by paths and stairways; however, the existing pedestrian paths are limited - not all are ADA-compliant and bicycle facilities are very limited. Given Corte Madera's vulnerability to climate change, the redundancy and resilience of the transportation network is especially important to ensuring the safety of the town's residents, employees, and visitors.

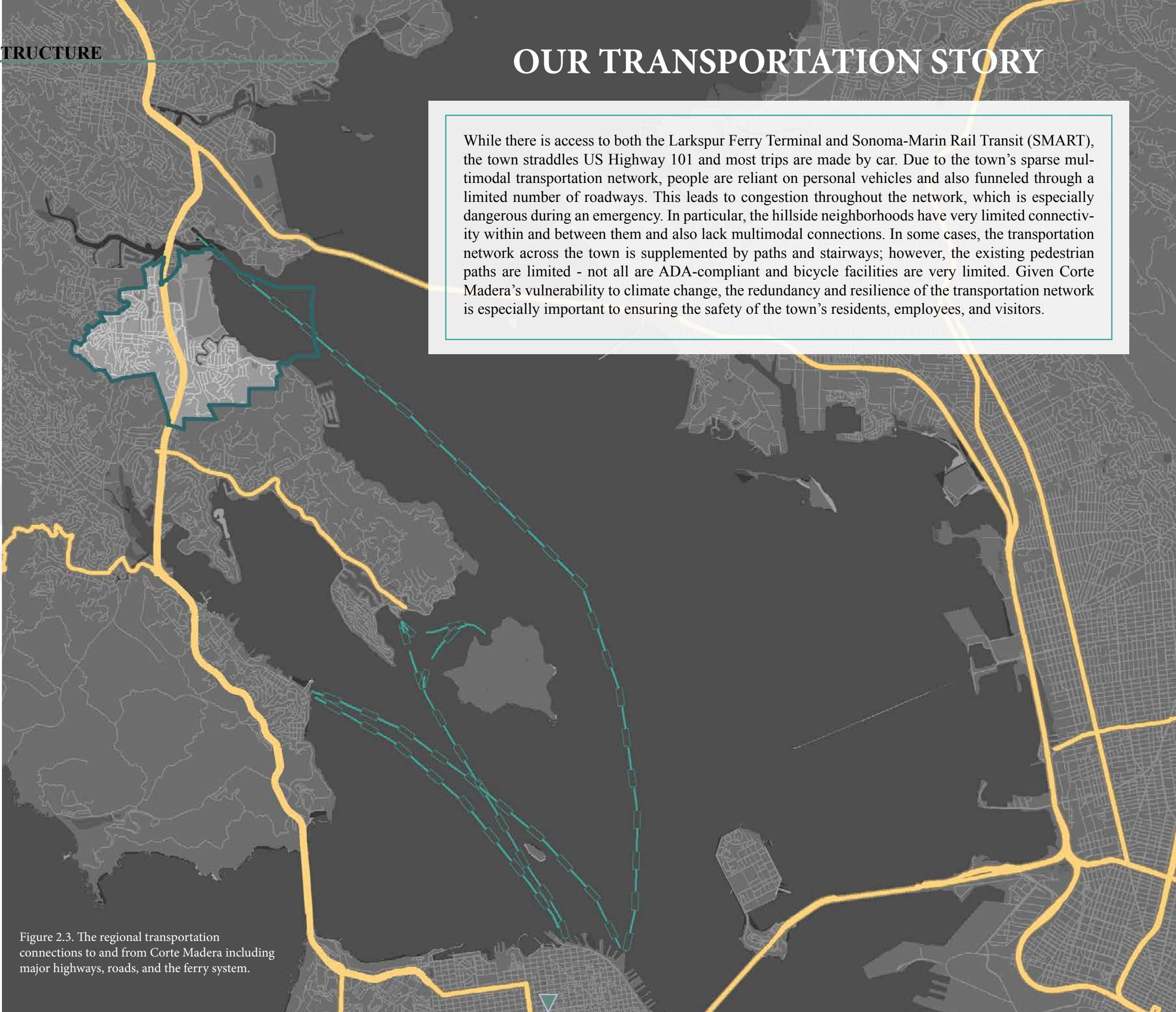

Figure 2.3. The regional transportation connections to and from Corte Madera including major highways, roads, and the ferry system.



COLLABORATE AND EDUCATE

The complexity and interconnectedness of climate change requires a significant investment in community engagement and education in order to increase awareness and resilience. In addition, Marin County's unique land-use, geography, and transportation network necessitates comprehensive and multi-jurisdictional adaptation approaches and solutions in partnership with local, regional, and state partners.

Programs that educate and inform residents, visitors, businesses, and local decision-makers can empower individuals to take actions to reduce risk for themselves. Programs that seek to bring community members together can create lasting connectivity among neighbors who can plan together to get out of harm's way.



FEATURED ACTIONS: COLLABORATE AND EDUCATE

Develop a climate awareness communications program and campaign that helps community members understand potential risks, solutions, and opportunities to address climate impacts.

Program
Lead: TBD

Community awareness is a foundation for community action. Although the climate crisis is an immediate and urgent issue, it is complex and requires a dedicated effort to build broad awareness.

Support the creation of a county-focused Task Force that guides a single, comprehensive, and multi-jurisdictional adaptation strategy for all of Marin County.

Program
Lead: The Town of Corte Madera and the Marin Climate and Energy Partnership

According to the Marin County Civil Grand Jury, more coordination is needed between municipalities, agencies, and the board of supervisors with regards to climate change adaptation planning. This task force would help efficiently coordinate regional efforts and make decisions in partnership with municipalities.⁸¹ The Marin Climate and Energy Partnership is supportive of broadening its mission and increasing the funding dedicated to supporting regional climate change mitigation and adaptation efforts, which should be given consideration.

Identify additional staff and/or resources to focus on implementation and monitoring of the Climate Adaptation Plan.

Policy
Lead: Corte Madera Planning Department

Corte Madera is a small town with a limited number of staff members who often have a wide range of duties. The Town could benefit from having an adaptation and resilience coordinator to help work across departments and guide the execution, implementation, and tracking of the resilience actions identified in this plan. In accordance with recommendations by the Marin County Civil Grand Jury, this coordinator could work directly with the Marin Climate Adaptation Task Force in order to better coordinate regional efforts.

Publish a guide or online portal of actions that commercial and residential property owners can take to make their homes and buildings more resilient to climate change.

Program
Lead: TBD

Supporting commercial and residential property owners to make their homes and businesses more resilient by providing resources, tools, and knowledge is an effective and efficient way to enhance resilience across the Town.

Expand the Town's Climate Action Committee to include Adaptation and Resilience.

Program
Lead: TBD

Climate change adaptation and mitigation planning must happen simultaneously. The new Town Climate Action Committee could help support, monitor, and report on climate mitigation and adaptation efforts happening across the community.



3

the shoreline





© Town of Corte Madera



The Shoreline neighborhoods of Corte Madera are home to valuable residential properties, critical infrastructure facilities, and vital portions of the Town’s transportation network. The prominent areas include the eastern residential neighborhoods of Mariner Cove and Marina Village, the Paradise Drive corridor, the Corte Madera State Ecological Reserve and tidal marshlands, and the northwestern neighborhood along Lucky Drive adjacent to Corte Madera Creek. Some of these areas already experience periodic flooding from stormwater runoff and/or king tides, and all are at low elevations putting them at risk of flooding during prolonged storm events.

Mariner Cove and Marina Village are established bay-side neighborhoods, which were built on filled baylands in the 1950’s.⁸² They have subsided as the bay mud and marsh soils settle under the weight of the infrastructure.⁸³ The neighborhoods are subsiding at a rate of up to 1.4 inches per decade,⁸⁴ further exacerbating the risk of coastal flooding and the localized impacts of sea level rise. Many homes are situated directly on the bank of San Clemente Creek and are currently protected from storm surge by earthen levees; however, during king tides, backyards and driveways can be flooded (as seen in the image above).

Corte Madera’s remaining tidal marsh and mudflats provide ecosystem services and have intrinsic value. The marsh and mudflats act as a first line of defense between the Bay and shoreline infrastructure, reducing wave heights and protecting inland areas from bay-side flooding. The tidal marshes also improve water quality by filtering out pollutants and trapping sediment, and they store carbon from the atmosphere. The Corte Madera Ecological Reserve, a large part of the marsh complex managed by the CA Department of Fish and Wildlife, is home to populations of rare and endangered species like the Ridgway’s rail, San Pablo

song sparrow, and California black rail.⁸⁵ The marshes of the Corte Madera Ecological Reserve provide valuable long-term habitat for these species and ecosystem services for the Town of Corte Madera. However, tidal marshes are vulnerable to the impacts of climate change, and future planning efforts must integrate adaptation planning for marsh ecosystems with planning for the built environment in order to preserve this valuable landscape, which is intrinsic to the character of Corte Madera and a critical stepping stone as one of the largest marshes in Southern Marin.

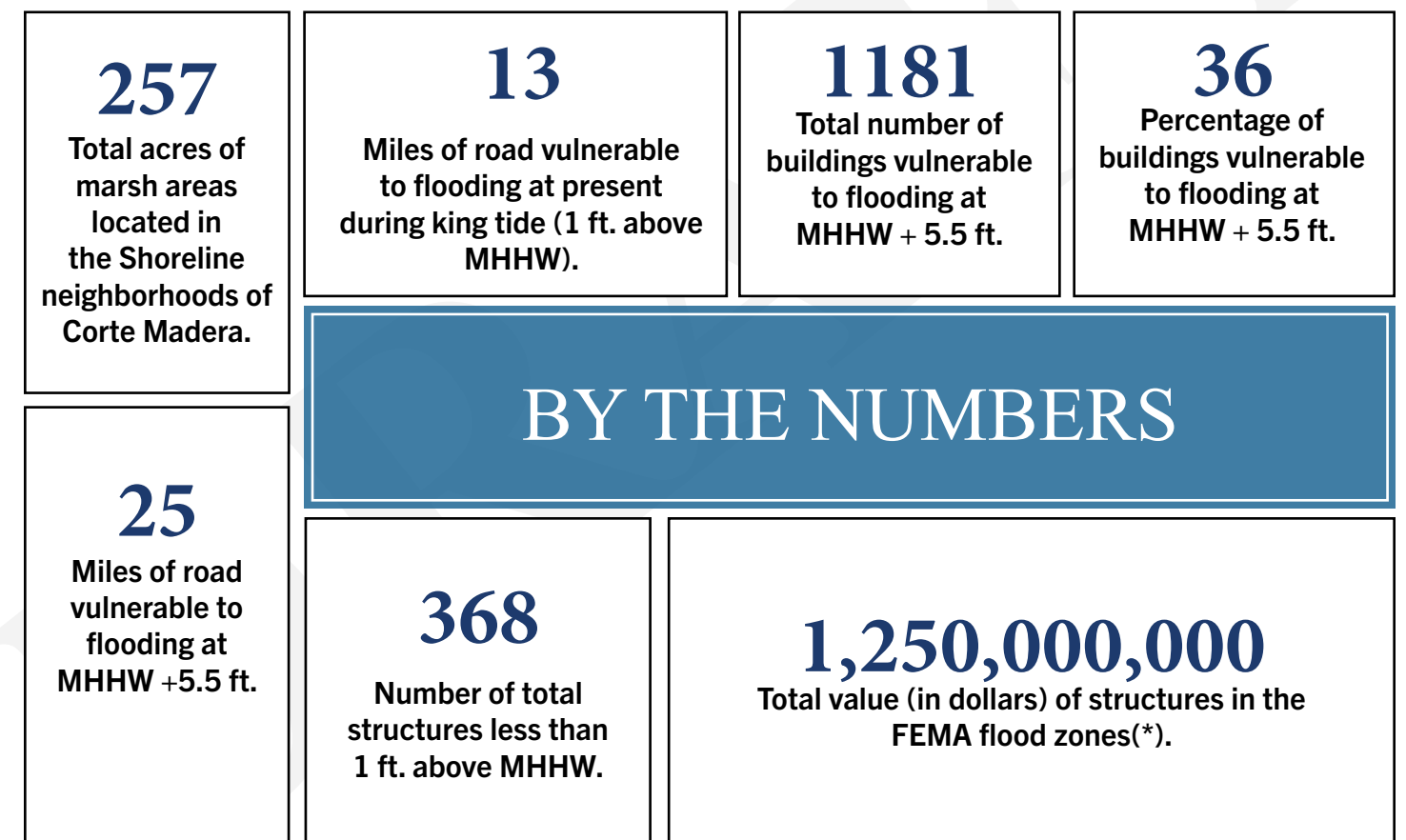

* Value calculation assumes \$1.3 million average/structure and includes all areas within the Town from Zillow.

Sea Level Rise in Corte Madera

Sea level rise is often visualized using inundation maps that represent specific SLR scenarios (e.g. MHHW + 12" SLR) or extreme water levels (such as a 100-yr storm event). However, this adaptation plan focuses on three total water levels that represent a range of future water levels associated with extreme tides and SLR. Each of the scenarios approximates either permanent inundation likely to occur before 2100 or temporary flood conditions from specific combinations of SLR and extreme tides. Flooding can occur temporarily during a large flood or permanently due to incremental SLR. Flooding in inland areas can occur without water overtopping the bayfront shoreline if there is a "backdoor" pathway of flooding from a different source, such as Corte Madera Creek, stormwater runoff, or groundwater emergence.

If no action is taken to further protect from and accommodate rising sea levels, the town will face extreme damage from flood waters.

Scenario	Threshold	SLR	"Event"
MHHW + 1 ft.	Episodic Flooding	0	King Tide
		1 ft.	Daily Tide
MHHW + 3 ft.	Levee Overtopping and Significant Flooding	1 ft.	5-yr
		3 ft.	Daily Tide
MHHW + 5.5 ft.	Chronic and Extensive Flooding	2 ft.	100-yr
		5.5 ft.	Daily Tide

Figure 3.1 - This table describes the thresholds reached at each of the water level scenarios and different combinations of SLR and extreme water level events that can create each scenario.

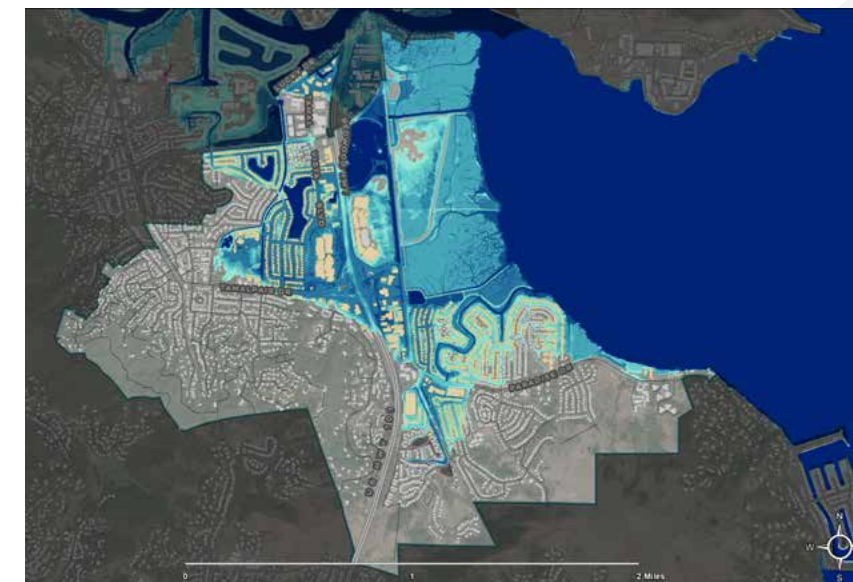

In Corte Madera during king tides, water levels frequently meet or exceed 1-foot above MHHW (top map). The center map shows inundation at 3 feet above today's MHHW. The bottom map shows inundation at 5.5 feet above today's MHHW. Note that the extent of flooding is similar between the 3 ft and 5.5 ft scenarios, but depths increase in the 5.5 ft scenario. The Town of Corte Madera does not experience the extent of flooding depicted on the 1-foot (top) scenario map during today's king tides. Currently, flood infrastructure protects much of the Town from 1-foot flood levels, even though the low-lying elevation of the land surface means much of the area would be inundated if no flood protection existed. Areas currently protected by infrastructure are depicted with a yellow border in the first map (MHHW +1 ft.). The flood inundation maps do not consider the duration of flooding from extreme tides or existing mechanisms for draining floodwaters from inundated areas (such as pump stations). While the map may overestimate the potential flood exposure during temporary flood events, the inundation maps and the overtopping assessment are still useful tools for evaluating the overall vulnerability of the Town to more permanent increases in water levels because they highlight how low the ground surface is relative to projected future water surface levels.

Figure 3.1. Maps depicting the MHHW + 1 (top), 3 (middle), and 5.5 ft. (bottom) inundation scenarios.

The Secondary Impacts of Flooding

Flooding can cause temporary or permanent business closures, decrease property values, close local and state roadways, and disrupt communications, utility and emergency response services.

Chronic flooding could jeopardize the homes and neighborhoods that contribute to the identity of Corte Madera. It can lower market values and leave houses undesirable or unsellable. Flood insurance for chronically inundated coastal properties could become increasingly expensive, or maybe not available at all. This could lead to a large number of coastal foreclosures and abandoned homes, lowering the value of homes in surrounding areas and force people to look to purchase/rent at higher elevations or in other municipalities. In addition, lower property values equate to less tax revenue that could lead to an increase in property taxes in order to pay for increasingly necessary improvements and fixes to existing infrastructure.⁸⁶

Shoreline Adaptation in Practice

While episodic flooding is a current reality, the Town has time to plan for and proactively manage future flooding. Due to the range of impacts that can occur as a result of sea level rise, a combined suite of policies, programs, and projects are needed to protect critical infrastructure and residents, reduce vulnerability, and create a more resilient community. It is important to acknowledge that future conditions (environmental, financial, and social) are uncertain and can change rapidly, which may require adjusting plans and considering options that may not be among the current highest priority alternatives. In addition, these decisions impact people's lives, safety, property, and critical ecological and public resources, so planning inclusively and with contingencies is extremely important. Overall, part of becoming a more resilient community in the face of climate change is being flexible in the approach to adaptation.

Adapting to sea level rise and coastal flooding requires proactive planning and strategies that generally fall into three main categories: protect, accommodate, and retreat.⁸⁷

- **Protection strategies** (*keep the water out*) utilize some kind of engineered structure, or other means, to defend a resource in its current location without changing the development itself.
- **Accommodation strategies** (*live with water*) require modification of existing developments, or design for new developments, to decrease flood risk, therefore increasing the resilience. Accommodation can happen at the individual parcel or structure scale (raising, floodproofing, retrofits, building material requirements) as well as at the community-scale (zoning ordinances, land use designations).
- **Retreat strategies** (*get out of the water's way*) focus on planning for long-term resilience and include actions that set the stage for relocation or removal of existing development out of hazard areas and/or limit the construction of new development in high risk areas.

No single category is considered “better” or “best”, as different types of actions are appropriate for different areas and for different hazard management and resource protection goals, all of which can change over time. In many instances, a hybrid approach to adaptation that utilizes actions across multiple categories is necessary to reduce vulnerability. For each category, actions fall into three key groupings of projects, policies, and programs, each of which are described in more detail in the following pages. The effectiveness and implementability of many actions are contingent upon decisions made around other actions; therefore, these actions are meant to be grouped into larger strategies which can get implemented over space and time. An example of the complex relationship between actions is demonstrated with adaptation pathways on pages 84-85 (adaptation pathway for Mariner Cove and Marina Village and pages 94-95 (adaptation pathway for the Marsh and RR ROW).



Corte Madera's shoreline neighborhoods are home to many of the Town's residents, shopping malls critical to the town's economy, schools, and other services. Though these neighborhoods are vulnerable to coastal flooding, residents would prefer to stay in place as long as possible. Actions in the “Protect” category tend to be near- to mid- term actions that can, through a mix of green, grey, and hybrid approaches, provide flood protection and ecological enhancements to maintain current land uses through the middle of this century. Thus, construction and enhancement of engineered infrastructure and environmental restoration measures may be central to Corte Madera's efforts to combat sea level rise.

Earthen levees and riprap currently protect the Town and residences from high water levels and storm surge,

yet, without intervention, these levees will eventually be overtopped by rising seas if not improved. The marsh serves as a natural buffer to sea level rise; however, marsh restoration and enhancement efforts are essential to improving the natural habitat and protecting the shoreline from rising seas and wave action.

While there are physical limits to the effectiveness of engineered protection measures in the long-term, these strategies can be critical to near- and medium-term resilience. It is important to regulate the construction of protective infrastructure to limit potential negative environmental impacts.⁸⁸ Well designed programs can help to inform the selection of appropriate actions, monitor environmental conditions, and assist residents and decision-makers in making optimal decisions.

Fortify or elevate existing shoreline flood protection infrastructure (e.g. levee, flood barrier, or sheet pile wall) or construct new infrastructure to protect residents and critical resources.

Project

Lead: Corte Madera Department of Public Works

Levees currently protect much of coastal and central Corte Madera from high water levels, and as sea levels rise, it will be necessary to strengthen and elevate existing levees to protect areas behind them from even higher water. (See *Mariner Cove and Marina Village* section on pages 78-85).

Require that future transportation infrastructure projects consider flood risk over the projected lifespan of the project.

Policy

Lead: Corte Madera Department of Public Works

Using future sea level rise and flood projections is essential for maintaining resilient roads and transportation infrastructure. While roads can still function with minimal flooding, understanding flood vulnerability over the lifespan of the project can help to reduce road closures, maintenance costs, and any disruption to essential travel.

Develop a program to provide property protection assistance to qualified homeowners and improve compliance with hazard preparedness requirements on their property.

Project

Lead: TBD

Individual homeowners can reduce flood vulnerability and maintenance costs by adhering to flood-proofing and building requirements specific to flooding. The Town could assist homeowners and property owners in preparing permits related to resilient building and design projects, and reduce the amount of time and effort needed to fill out, review, and approve permits. The Town could also reduce fees associated with such processes with the intent to make the process more accessible for property owners seeking to comply with regulations.

Establish a sea level rise monitoring program, and identify leading indicators and decision points/thresholds needed to protect infrastructure.

Program

Lead: TBD

Sea level rise science and projections are always improving; however, there will always be some level of uncertainty around the timing and rate of sea level rise. To combat this uncertainty and allow the Town to be flexible and adaptive in its response and action, developing a robust monitoring program and establishing thresholds for action is important. For example, the Town could work with others in the region to: 1) Identify thresholds for maximum flood depth or frequency of flooding after which roads will need to be elevated, relocated, temporarily closed, or abandoned (could include community survey to understand point at which flooding is perceived to be chronic and causing a problem); 2) Incorporate sea level rise inundation maps into the Town's GIS mapping system, and utilize GIS as a tool for tracking increased flooding and sea level rise.

Case Study: Levee Improvements at Foster City (San Mateo County)

Foster City is a bayside development on former marsh and faces similar challenges to the neighborhoods of Mariner Cove and Marina Village in Corte Madera. A levee system surrounds most of the bayfront perimeter of Foster City, protecting the low-lying urban area from flooding. In 2014, the Federal Emergency Management Agency (FEMA) determined that the existing system does not meet minimum flood protection requirements. Given its location on the Bay, and lacking a significant fringing marsh, the levee needs to accommodate both storm surge and wave runup. The existing levee ranges from 12-13 feet NAVD in elevation, but to meet FEMA's current standards it must be raised to 16 feet NAVD in certain areas, and even higher to protect from future sea-level rise.⁸⁹ To do this, the crest elevation will be increased by adding a sheet pile wall to the existing levee. Due to impacts on views and geotechnical limitations, continuing to raise the sheet pile wall to protect from both storm surge and wave runup beyond 2050 may not be possible. A coarse beach has been proposed that would be placed in front of the levee to reduce wave runup and extend the life of the sheet pile wall. To reduce risk for their community and avoid designating Foster City as a flood zone (which would require expensive flood insurance for most homeowners), voters passed Measure P in 2018. This measure authorized the City to issue a \$90 million general obligation bond to fund the levee improvement project. Measure P will cost property owners approximately \$40 per \$100,000 of assessed property value annually for levee improvements for 30 years, much less than the estimated cost of flood insurance.⁹⁰

There are some key differences between Foster City and Corte Madera; today, much of Corte Madera lies within the FEMA floodplain, while Foster City (though very low-lying) has been exempt from flood insurance requirements due to the levee system. Because nearly all of Foster City is protected by the levee, fundraising by raising taxes for the whole city is easier than it might be in Corte Madera, where only a small portion of the city's population will directly benefit from new flood risk management infrastructure. In Foster City, homes are ringed by an external road, while homes in Corte Madera are directly adjacent to the Bay. Finally, Foster City also has an existing natural fringing beach along part of the shoreline, where Corte Madera does not (though it does have more extensive marshes). Both cities aim to protect residential neighborhoods constructed on Bay fill in former marshlands from the impacts of rising sea levels. More information about the Foster City project is available [here](#).



© Google Earth



ACCOMMODATE

One way to adapt to rising seas is to learn how to live with water. Creating space for more water in the landscape is a critical piece of the adaptation puzzle essential for Corte Madera. In many instances, accommodating rising sea levels by modifying existing structures and infrastructure can provide a cost effective way to help reduce current and future flood risk. Actions like elevating certain road segments or finished floor elevations can prevent further flood damage. To further reduce the community's vulnerability to flooding, the Town can take additional actions. Many of the recommended policies are flexible and can be adjusted as conditions or community needs change.

A large portion of the Town currently lies in the floodplain, which is considered a Special Flood Hazard Area (SFHA) and designated by FEMA. To accommodate flooding from Bay and creek sources in

these areas, development must meet particular building requirements and adhere to specific regulations. In an effort to reduce flood insurance rates for residents, the Town participates in the FEMA/NFIP Community Rating System (CRS), which determines insurance discounts based on flood risk reduction and floodplain management efforts. The CRS credits community efforts to reduce flood risk by assigning points for different activities. Corte Madera is currently credited as a CRS Class 7, which translates to a 15% savings on all flood insurance rates.⁹¹ For more information on the CRS classes and requirements, check out [FEMA's resources](#). While the FEMA and CRS community participation requirements help reduce vulnerability to flooding, these requirements are based on historical flood data and do not account for future flood risk from extreme precipitation events or sea level rise.



FEATURED ACTIONS: ACCOMMODATE

Conduct a comprehensive, finished floor elevation inventory of buildings within current and future flood risk areas.

Project

Lead: Corte Madera Planning Department

This inventory can help the Town make the most informed decisions on where and when to most effectively invest resources by not relying solely on the bare-earth elevation data to determine at-risk structures or areas for future investments.

Elevate portions of Lucky Drive and Paradise Drive at risk of flooding.

Project

Lead: Corte Madera Department of Public Works

Some portions of Lucky Drive already flood during high water events and king tides. These sections of road should be elevated to withstand sea level rise and storm surge for the lifespan of the roadway (*see Lucky Drive - page 76, - and Paradise Drive - page 77 - concept design sections*).

Update real estate transaction disclosure requirements for homes in designated flood-risk zones to include hazards related to climate change including prior flood damage and current and future flood risk.

Policy

Lead: Corte Madera Planning Department

Work with real estate agencies and others to develop a disclosure ordinance that requires that sellers disclose past flood events and building elevation and location relative to Town defined flood zones. This will help buyers become aware of climate related risks.

Require additional freeboard above base flood elevation.

Policy

Lead: Corte Madera Planning Department and Corte Madera Department of Public Works

Homes in the flood zone are currently required to be elevated one foot above the 100-year (1% annual chance) flood water elevation. Requiring additional freeboard (e.g. 3 feet above base flood elevation (BFE) for new structures can reduce vulnerability to flooding for homes in designated areas. For existing structures, these elevation requirements could be triggered at the time of "substantial improvement" or "significant damage" (threshold determined within municipal ordinance).



Policy Consideration: Corte Madera Coastal Resilience Overlay Zone

Zoning is the most powerful tool that local governments can use to preemptively mitigate hazards by determining what is at risk, what is safe to build, and where it is safe to build. By analyzing vulnerabilities and planning for impacts, local governments can shape landowner expectations and build support for adaptation efforts. Through regulations, local governments can ensure that fewer people and less infrastructure is in harm's way as sea level rises and that developers site and construct new, more resilient buildings.⁹²

“An overlay zone is a land use planning area where additional zoning requirements ‘overlay’ the original requirements of the underlying zone.”⁹³

The development of a coastal resilience overlay zone designation would serve a number of different purposes. Once in place, an overlay zone would provide landowners with the warning that they are currently, or will soon be, in the direct path of rising seas or chronic flooding. Over the longer term, phased implementation of restrictions and/or regulations can reduce or halt rebuilding in hazardous areas. Overlay zones can be designed to remain “transparent” and not impact the properties until a future triggering event (such as reaching an established king tide elevation) requires the prescribed changes. They can also be designed in a way that certain regulations are in place until a particular event occurs, decision is made, a defined threshold is reached, or other conditions change, which triggers those regulations to relax or change. These following strategies can be implemented at different times, depending on the Town's goals and needs, and some can occur simultaneously.

Designate zones within the flood hazard area where regulations are tailored to specific conditions, characteristics, and adaptation goals.

How zone boundaries are drawn requires the Town to weigh the following policy considerations: community goals for particular areas; the area's vulnerability and the immediacy of adaptation needs; the extent and type of existing development (critical facilities, residential, commercial); how precautionary the town wants to be in regulating the different zones; and both the extent of existing protective measures and the feasibility and likelihood of future protective measures in the area.⁹⁴

Floodplain Frontline Zone: This zone could consist of structures and habitat areas that are the most vulnerable to flooding from sea level rise and the hardest to cost-effectively protect from projected sea level rise (or maybe unfeasible to protect with hard infrastructure) in the near-term or

long-term. This area could be drawn using existing data and observations or after specific regional or State sea level rise vulnerability maps were adopted for regulatory use for local governments. The following is a list of potential tools that could be employed in this zone.

- **Restrict rebuilding:** Limit or prohibit redevelopment of nonconforming structures, or upgrades to existing structures.
- **Implement development moratorium.** Prohibit the building of new structures for up to two years from implementation, or until certain conditions or protective measures are in place.
- **Downzone permitted use:** limit new development and redevelopment to low-density/low-intensity uses (such as recreational or open space).
- Increase setbacks: require that structures be setback on the lot as far landward or upward on a site as feasible (“maximum practicable setbacks”).
- **Limit the size of structures:** permit only smaller structures that are built to be more easily re-located, will put fewer people at risk, and will minimize the economic consequences of floods.

Floodplain Accommodation Zone: This zone designation can allow for continued development and redevelopment while requiring that structures be sited and built in ways that are more resilient to flooding and reduce vulnerability to sea level rise. While regulations within this zone would be broadly applied with the goal of resilient growth and development, careful consideration should be taken for the individual siting of new development, especially critical facilities and utilities, that may need additional analysis.

The following tools could be employed in this zone:

- **Increase freeboard or structure elevation:** require additional freeboard consistent with estimates for projected SLR over the projected life of the structure (e.g. X feet of SLR over X years) or adding height to the BFE to accommodate sea level rise (e.g. increase to 3 feet above current BFE). Where freeboard is infeasible, the Town could require that structures be flood-proofed.
- **Require more resilient and adaptive building types:** require all new (and upgraded) commercial and residential developments be built using resilient materials and best practices.
- **Adjust building size/height and densities allowances:** consider adjusting building size and density allowances to reflect Town goals and housing requirements.
- **Streamline permitting process:** reduce the resources needed for property owners to acquire necessary permits to comply with flood regulations.

Most of the tools at the Town's disposal are not currently employed within the nine jurisdictions of Marin County, except freeboard elevation requirements and requirements for flood-resistant designs. Marin County requires structures to be built an additional foot above the FEMA-required base flood elevation. These requirements could be applied to the appropriate newly-designated zones. Some additional conditions or requirements may apply to some, or all, structures falling within a coastal resilience overlay zone (or specific zone).⁹⁵ Additional potential actions, conditions, or requirements can be found in Appendix X.



RETREAT

Local governments and decision makers are increasingly having to discuss ways to best protect people, development, infrastructure, and coastal ecosystems from sea-level rise, coastal flooding, and subsequent land loss. Planning for strategically relocating people and infrastructure out of harm's way is synonymous with long-term planning for a safe and resilient future. While there are many actions a government can take to protect residents and infrastructure in the near- to mid-term, it's essential that discussion of the longer-term vision of the community occur in tandem, as these changes can require significant planning and analysis. There are actions that can be taken now to avoid significant damage from chronic flooding and reduce the financial burden on residents and the Town that are likely to occur if action is not taken. Planning for long-term resilience of shoreline homes can create new opportunities for homeowners to resettle in areas less vulnerable to coastal hazards before sea level rise is knocking on their front door.

Managed retreat is the voluntary and planned movement and transition of people and infrastructure away from vulnerable coastal areas.

Given the rates of sea level rise and subsidence in some of the Town's coastal neighborhoods, it is difficult to imagine a community that does not look radically different in 80 to 100 years. Preparing the community for potentially more than 6 feet of sea level rise by 2100 and additional flooding from groundwater rise means reenvisioning what coastal neighborhoods look like and how they function as part of the larger community. Over time, flooding from rising sea level will likely decrease the value of shoreline properties in Marin County and increase the cost of flood insurance, causing many homeowners to suffer financial losses. Similarly, the local government will also incur additional costs for infrastructure improvements and maintenance, health and human services, and emergency services.

Across the country and the world, most movement of people and infrastructure occurs post-disaster, such as after a hurricane, significant flood damage, or repetitive loss. However, many local governments are looking to proactively move people and property out of harm's way to avoid costly emergency actions and are exploring the feasibility of different programs and policies.

There is no "one size fits all" approach to managed retreat. Communities across the country and world are taking creative approaches to planning and implementing strategic retreat from the most vulnerable shoreline areas, using a mix of programmatic, regulatory, and educational strategies. While managed retreat as it is envisioned now may not be the answer for every coastal community, it is still essential to begin the difficult conversation with Corte Maderas. These discussions can help ensure that everyone affected by climate change has the opportunity to voice their concerns and con-

sider all options. Given the long lead time associated with these types of policy decisions, it is important to have these discussions while discussing other more traditional protection and adaptation strategies.⁹⁶ Having the goal of planning early for long-term resilience can help the Town provide assistance to those at risk rather than leave people to do nothing or plan individual. Sea level rise is no longer an issue for future generations and holistic discussions of a variety of strategies, including retreat, should begin now.



FEATURED ACTIONS: RETREAT

Begin the community conversation around long-term impacts of sea level rise.

Program

Lead: TBD

Involving the community from the beginning of the planning discussion is essential for any potential future success of managed retreat programs. Educating residents on the future projections, impacts, and potential adaptation alternatives can help to bring the community along and garner support for future endeavors.

Form a regional strategic retreat advisory board to investigate the potential and feasibility of managed retreat within Marin County and the surrounding region.

Program

Lead: TBD

Regional collaboration is essential for early planning and discussion around the feasibility of managed retreat in the region. Part of this should include the discussion on where displaced residents could be moved and how this program would work within the region.

Assess the costs and benefits of investing in protective infrastructure vs. retreat.

Program

Lead: TBD

An analysis of the costs and benefits of constructing protective infrastructure versus investing in moving out of harm's way would be useful to determine the most appropriate use of Town funding.

Retain the services of a financial analyst to explore the financial viability of an acquisition program.

Program

Lead: TBD

This is an essential early step to determining the feasibility of longer-term resilience options. A potential acquisition program could utilize a variety of funding sources, such as FEMA Building Resilient Infrastructures and Communities (BRIC), and tools to buy properties from willing sellers in established areas.

Require flood risk status be disclosed to potential homebuyers of properties in highly vulnerable areas.

Program
Lead: TBD

Corte Madera does not currently require that potential homebuyers are informed of the current and future flood risk of the property of interest. By requiring this information be shared, it allows the potential purchaser to make a more informed decision. This can also be an opportunity to help people understand that the government cannot, and is not legally obligated to, ensure that property owners will not experience loss. It can help the market shift the future potential risk into pricing of homes. It can also serve as a means to explain that government funds (from taxpayers) are not required to pay for the costs of risks knowingly undertaken by property owners and purchasers.

Restrict significant redevelopment or improvement of existing properties in highly vulnerable areas.

Policy
Lead: Corte Madera Planning Department

If combined with regulations that prevent new development in highly vulnerable areas, this can even further reduce the number of properties in areas of high current and future flood risk. However, this can result in the slow deterioration of properties and cause significant financial burden to homeowners in the near term.

Initiate an outreach and education campaign focused on community awareness and involvement in long-term shoreline planning.

Project and Program
Lead: Corte Madera Planning Department

It is essential to involve the community in early planning discussions around a long-term vision for the community. This campaign can focus on educating residents and business owners on current and future flood risk, including sea level rise projections, feasibility of different adaptation strategies, and how different strategies and alternatives impact residents and the community as a whole.

Case Study: Imperial Beach, California

The City of Imperial Beach proposed a plan to move residential structures away from the most vulnerable shoreline areas using two possible methods. The first option being proposed was through acquisition programs, where the local government purchases properties from homeowners and rents them back (called a lease/buyback program); renting these properties back out can allow for the City to recoup a portion of the buyout costs. The second option explored the feasibility of a Transfer of Development Rights (TDR) program that involves a transaction between the City and homeowner, where the City provides a housing option in a “receiving areas” (where residents would move) in exchange for the homeowner giving up development rights to their property in the “sending area.” The decision to pursue and propose these programs to the community was not taken lightly. The City conducted a cost benefit analysis on multiple adaptation strategies, and found that transitioning residential housing away from the shoreline had the highest net benefit through the end of the century. Despite the City’s research into the possible retreat strategies, the community was strongly opposed to these strategies. The latest Imperial Beach Local Coastal Program update does not consider managed retreat as an option.^{97,98} Although this plan was not successful, there are many lessons to be learned from this city’s approach to community engagement.

- **Engage the community early in the discussion and planning process.** If the community is well informed of the mechanisms of the proposed programs--what is and isn’t involved--they are less likely to reject the idea due to misinformation or fear.
- **Invest in the time to educate the community on the impacts of sea level rise and the pros and cons of possible adaptation strategies.** The more educated the community is on the localized impacts of sea level rise, the better they will understand the need to plan for long-term resilience. If shown the possible solutions, and the costs and benefits for each, it is possible that the community will come to the determination on its own that managed retreat is necessary.

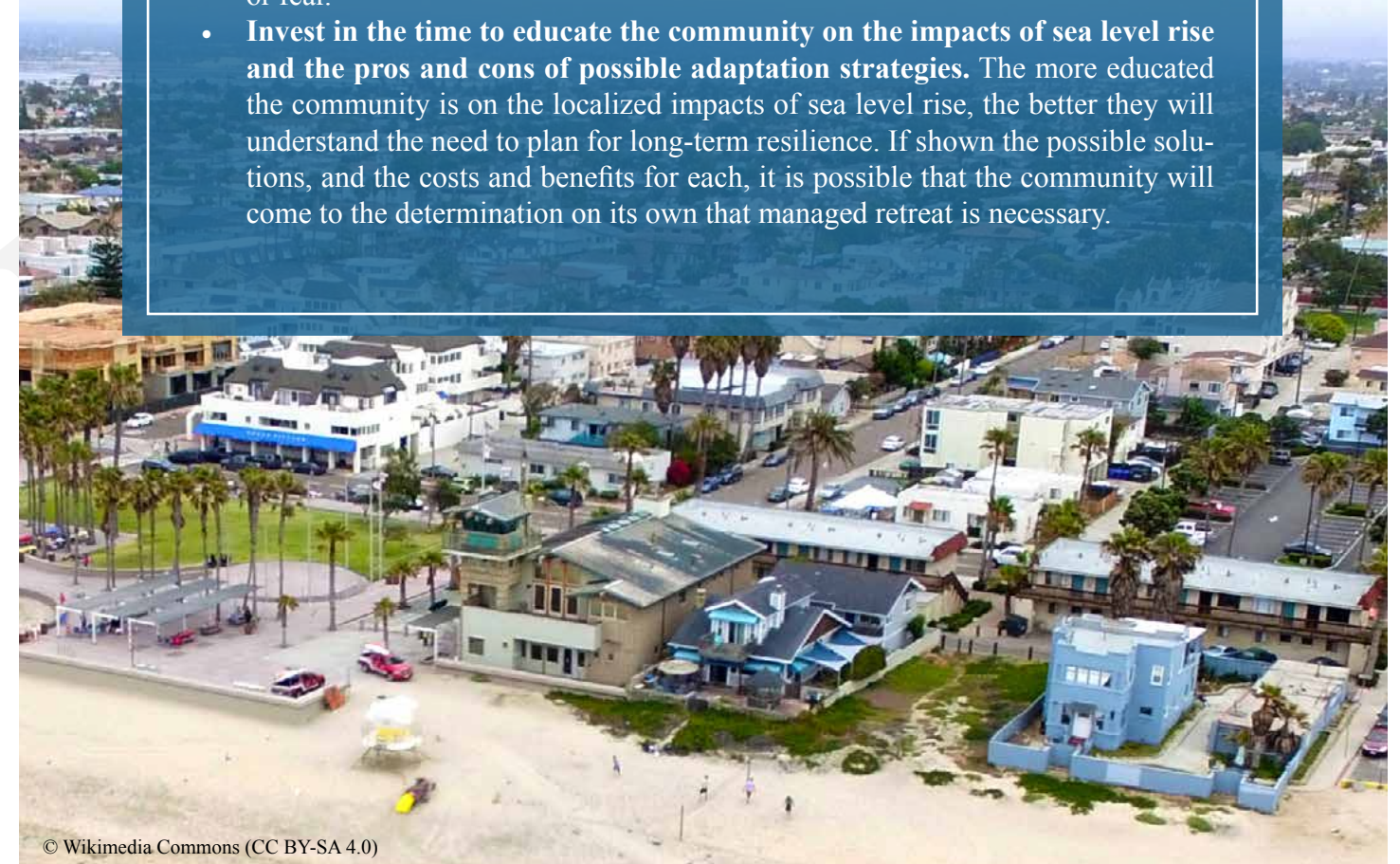

NATURE-BASED ADAPTATION

Natural and nature-based measures are physical landscape features that are created and evolve over time through the actions of environmental processes, or features that mimic characteristics of natural features but are created by engineering and construction (in concert with natural processes) to provide coastal protection and other ecosystem services.⁹⁹ Nature-based adaptation measures are only appropriate in certain landscape settings. They can be used in combination with other appropriate nature-based measures, or in hybrid combinations that include both nature-based measures and conventional gray infrastructure measures. Two examples of suites of nature-based adaptation measures working in concert to provide flood protection and habitat benefits are shown in Figure 3.2 and 3.3. Examples of nature-based measures that are suitable in Corte Madera are tidal marshes, ecotone slopes, submerged aquatic vegetation, and coarse beaches, each of which are described in more detail below.

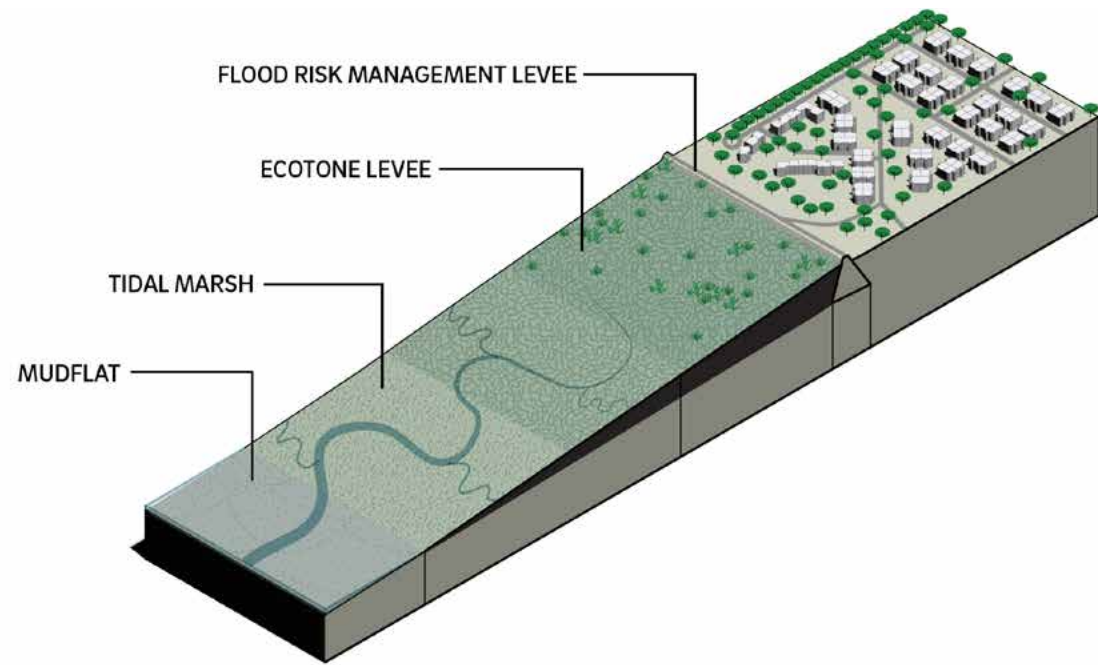

Figure 3.2. Example of multiple “gray” (traditional) and “green” (nature-based) adaptation actions working in concert to provide flood protection and habitat benefits. Illustration by Micaela Bazo, SFEI. Adapted from the SF Bay Adaptation Atlas (SFEI & SPUR 2019).

Tidal Marshes

Protecting, maintaining, and restoring tidal marshes and their associated tidal flats is critical for sustaining their flood risk management services with a changing climate.¹⁰⁰ The topography of the marsh and its associated mudflat plays a significant role in wave refraction, shoaling, and breaking. Wide marshes at Corte Madera are an asset in wave attenuation. Stabilizing the outer edge of the marsh by placing coarse beaches can help maintain marsh width by reducing erosion. Specific actions include restoring tidal action to diked baylands to restore marshes, planting native species to accelerate colonization, placing sediment to raise subsided areas, and creating marsh mounds - higher areas within marshes to provide high-tide refuge.¹⁰¹ In existing marshes this measure might also include sediment placement to help maintain marsh elevation with sea level rise.

Ecotone Slopes

Ecotone slopes are ramps (with a length to height ratio of 10:1 or gentler) bayward of flood risk management levees and landward of a tidal marsh. They can provide wetland-upland transition zone habitat when properly vegetated with native clonal grasses, rushes, and sedges.¹⁰² Ecotone slopes can attenuate waves before they reach the levee, provide high-tide refuge for marsh wildlife, and allow room for marshes to migrate upslope with sea level rise.¹⁰³ In Corte Madera, there is a unique opportunity to use on-site material (dredge spoils at the Golden Gate Bridge District parcel) to create an ecotone slope along the railroad embankment, connecting a future flood-risk management levee to the marsh.¹⁰⁴

For more information about nature-based sea level rise adaptation strategies, please refer to the [San Francisco Bay Shoreline Adaptation Atlas](#).

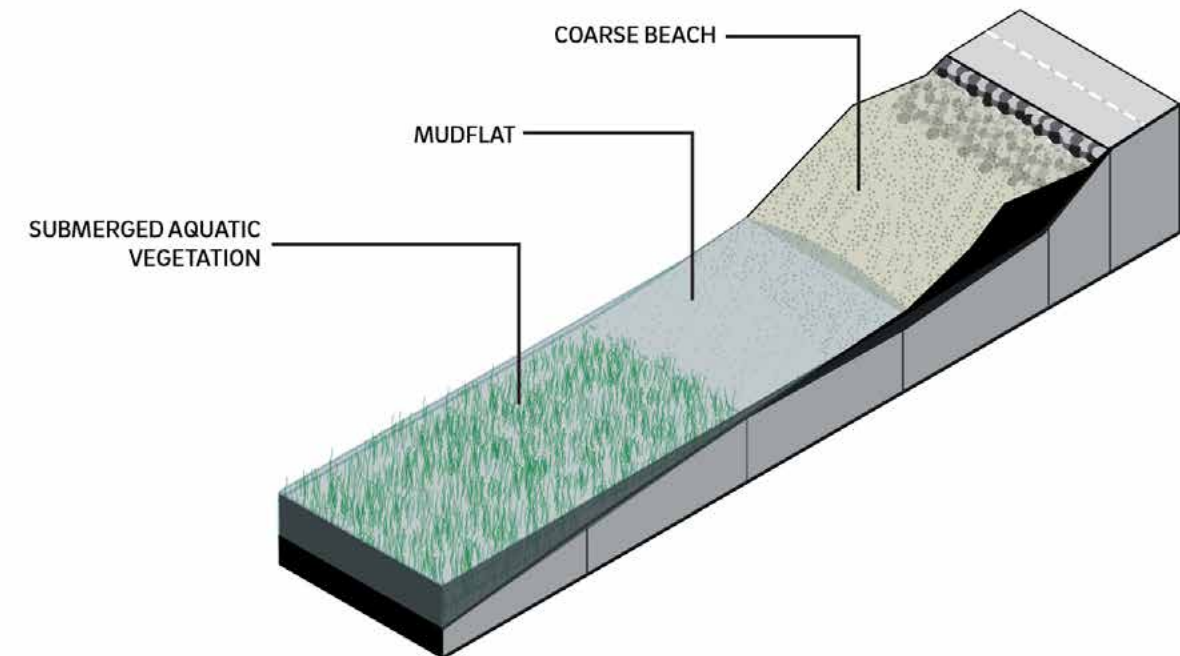

Figure 3.3 - Submerged aquatic vegetation, mudflats, and coarse beaches are natural features that can reduce the impact of wave action on the shoreline. Illustration by Micaela Bazo, SFEI. Adapted from SF Bay Shoreline Adaptation Atlas (SFEI & SPUR 2019).

Submerged Aquatic Vegetation

Submerged aquatic vegetation refers to all underwater flowering plants, and contributes to trapping sediment and slowing shoreline erosion.¹⁰⁵ Eelgrass (*Zostera marina*) is the main species in the lower parts of the San Francisco Estuary, but other submerged vegetation species exist throughout the Bay as well. However, submerged aquatic vegetation cannot grow anywhere; salinity, light, and substrate are limiting factors for eelgrass beds, and they do best where current speeds and wave energy are not excessive. Potential exists to establish eelgrass beds at depths less than 2m in broad swaths along the shores of Corte Madera bayward of the tidal marsh.^{106,107}

Beaches

Coarse or composite estuarine beaches are dynamic features that can consist of a mixture of sand, shell, gravel, or cobble.¹⁰⁸ Coarse gravel and cobble beaches can dissipate wave energy over shorter distances than marshes and therefore may be more suitable within an urbanized estuary that has limited space.¹⁰⁹ Beaches can be placed in front of levees, roads or other infrastructure vulnerable to wave overtopping, or in front of marshes vulnerable to erosion. In addition, groins or other retention structures (large woody debris is one option) should be considered for beaches implemented along shorelines where the dominant waves tend to transport sediment down the shoreline.

SHORELINE FOCUS AREAS

The previous pages have laid out numerous adaptation strategies that may be suitable for implementation in the Town of Corte Madera. In the following section, conceptual adaptation strategies are introduced for areas of the Town vulnerable to rising sea levels. Each of these strategies employs a range of measures (protect, accommodate, and retreat) based on the goals of the Town. Because nature-based measures may perform better than traditional engineered infrastructure while potentially costing less and providing more co-benefits,¹¹⁰ they have been incorporated into the conceptual designs as much as possible. No single adaptation strategy will protect the Town from flooding indefinitely, so adaptation pathways are presented that demonstrate the approximate time period of protection that may be afforded by certain measures, and decision points that can be used to determine when to implement a new strategy.

The four shoreline focus areas range in land use types: critical road infrastructure for the Town of Corte Madera, single-family residential neighborhoods in Mariner Cove and Marina Village, and the tidal marshes of the Corte Madera Ecological Reserve. Each focus area faces near term vulnerabilities, which could be addressed by the conceptual adaptation strategies detailed on the following pages. Each of these areas are in different stages of the planning process. For some, alternatives and costs have been explored, and for all, further planning and discussion are needed with the variety of stakeholders and landowners critical to making tough planning decisions.

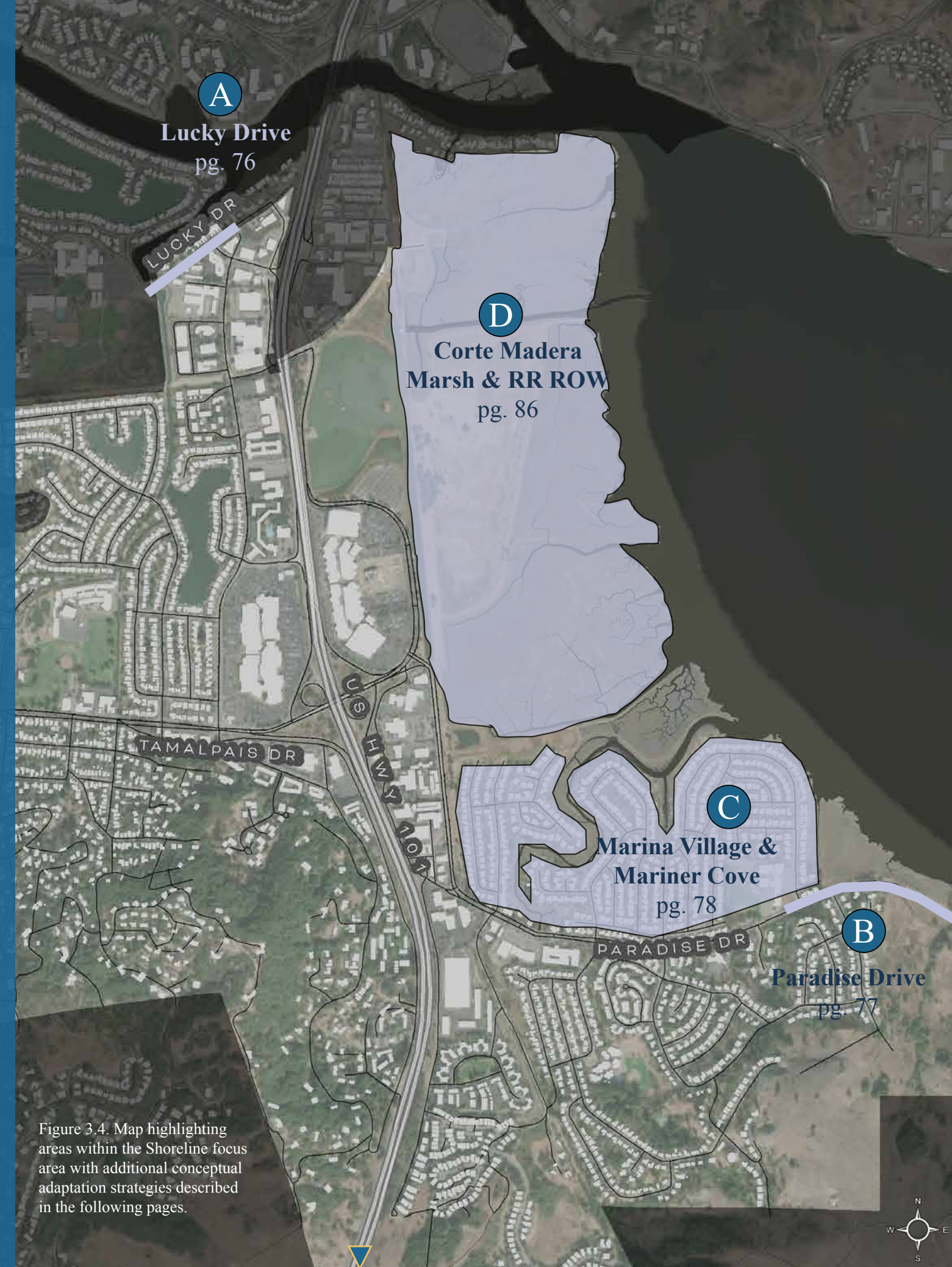

Figure 3.4. Map highlighting areas within the Shoreline focus area with additional conceptual adaptation strategies described in the following pages.

A. Lucky Drive

Lucky Drive is a short-yet-essential stretch of roadway that connects Corte Madera and surrounding municipalities and US Highway 101. This stretch of road is a critical access point to US Highway 101 and the only way to get to many homes and commercial properties in the Town. Lucky Drive is susceptible to flooding from Corte Madera Creek during heavy precipitation events and vulnerable to sea level rise.

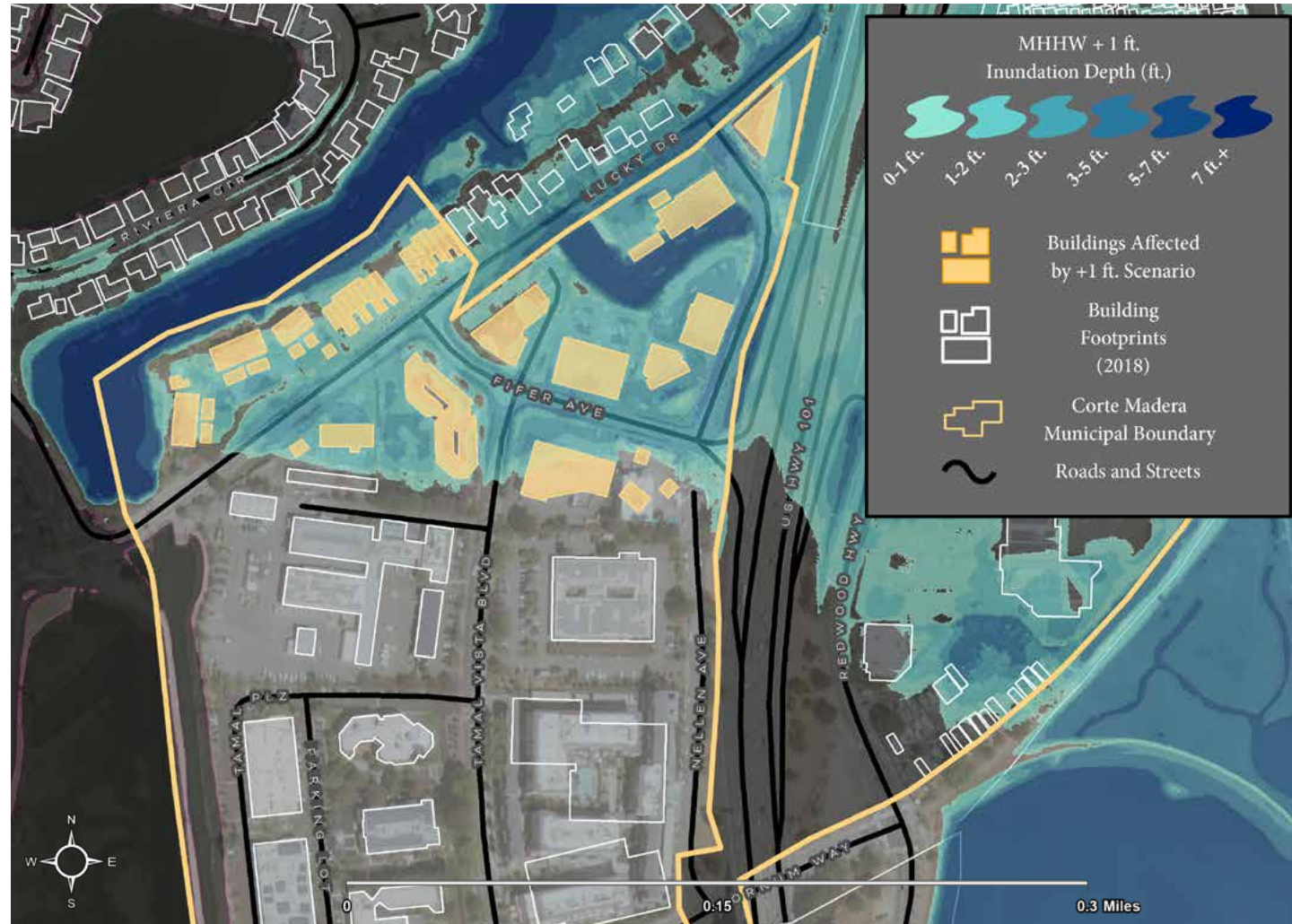

Figure 3.5. Section of Lucky Drive under a MHHW + 1 ft. scenario (approximately equivalent to a king tide). The area highlighted in yellow is currently protected from existing stormwater infrastructure, but coloring depicts water inundation levels without existing infrastructure in this protected area.

Despite being protected from temporary flooding by stormwater pumps, a section of Lucky Drive still floods during king tide events, especially when a king tide occurs during a period of high rainfall. To reduce the risk of flooding Lucky Drive, the roadway will need to be raised. The project team assessed the potential impacts of raising Lucky Drive from Doherty Drive to the northern Town border to a minimum elevation at the back-of-sidewalk of 10.7 ft (NAVD 88). The 10.7 ft NAVD88 elevation would move the roadway above the current 100-year flood event and allow for an additional 13” of sea level rise over the lifespan of the roadway (~30 years). This would make the roadway above the 100-year flood event in the 2050s. These improvements should be made in conjunction with a proposed roadway reconfiguration to incorporate a two-way protected bikeway on the north side of the street.

The Town has already submitted a grant application to cover the majority of the costs for raising Lucky Drive and is looking to complete this project in the next three to five years. For more details on the conceptual design, elevations, and other considerations see Appendix X.

B. Paradise Drive

Paradise Drive is another critical regional transportation corridor connecting Tiburon to the Town. It is designated as part of the Bay Trail and provides access to the Marin Montessori and Marin County Day schools and other residences. The Town has been looking into resurfacing the road, expanding bike lanes, and making other roadway improvements for a few years.

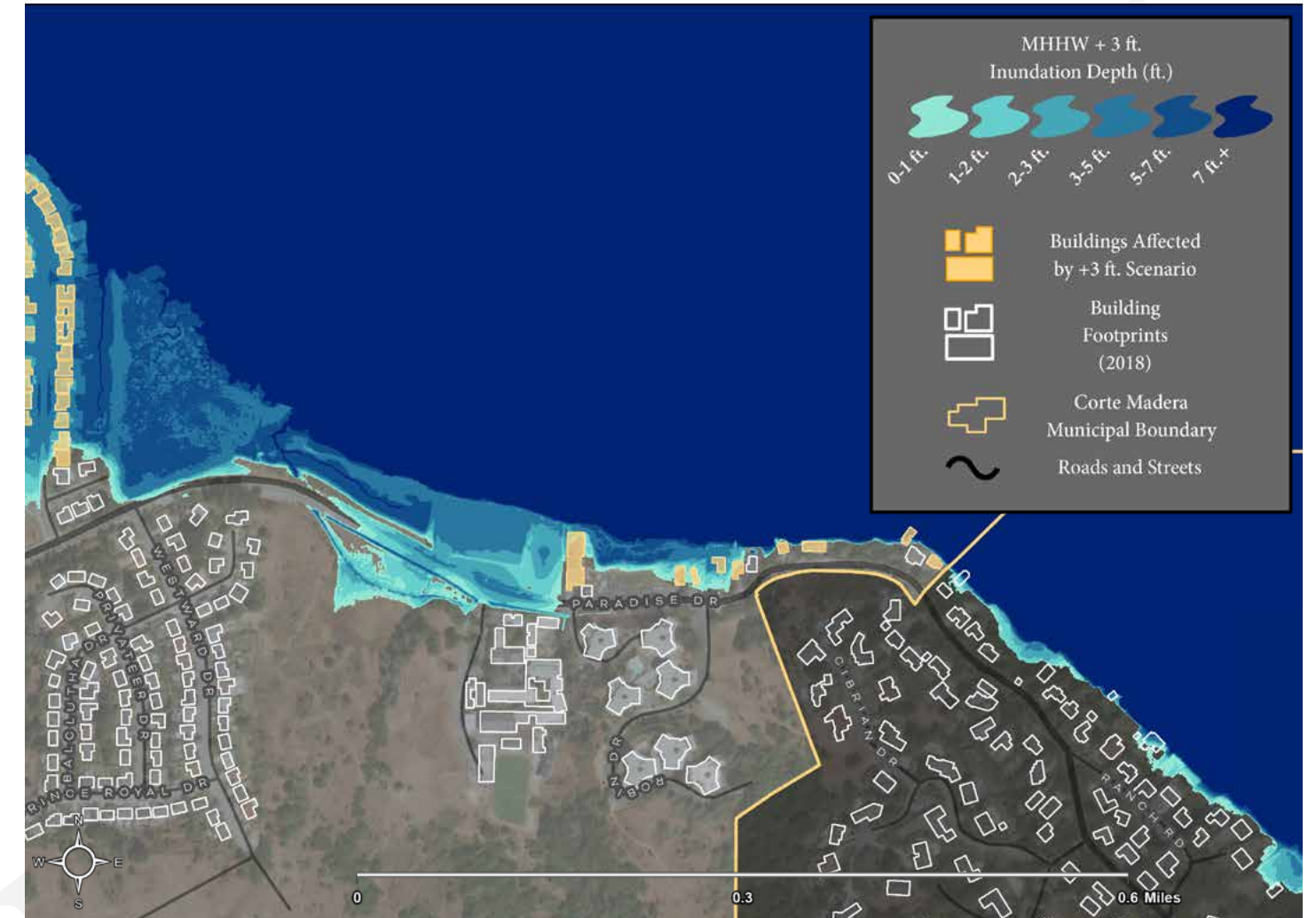

Figure 3.6. East Paradise Drive under a MHHW + 5.5 ft. scenario. Color shading depicts approximate depth of inundation.

To reduce the risk of flooding Paradise Drive, the roadway will need to be raised. The project team assessed the potential impacts of raising Paradise Drive from Westwood Drive to Robin Drive to 11.6 ft (NAVD 88), in conjunction with the proposed resurfacing and widening effort. The elevation of 11.6 ft (MHHW + 5.5 ft) would take into account sea level rise and elevate the road above the 100-year flood event in the 2070s. The proposed roadway profile is required to be at a minimum elevation of 12 ft or higher, assuming a standard 2% roadway crown. With existing centerline elevations ranging from 7.0 ft to 11.5 ft along this segment of Paradise Drive, in some areas the roadway will need to be raised up to 5.0 ft to address the anticipated water level of MHHW + 5.5 ft. The primary potential impacts of raising Paradise Drive include disrupting connections to adjacent roadways and driveways, relocating utilities, raising the pedestrian overcrossing for the Marin County Day School, and navigating environmentally sensitive areas. The Town is considering elevating the road as part of an already identified roadway resurfacing project in the next five years. More information on the details and core considerations that would need to be addressed as part of this project are available in Appendix X.

C. Mariner Cove & Marina Village

The Mariner Cove and Marina Village neighborhoods are a mix of residential development and critical marsh habitat. The neighborhoods were constructed in the 1950s and 1960s by placing fill material on top of tidal marsh and bay mud that in some places is more than 100 feet thick. Channels, culverts, pump stations, and the existing levee protecting Marina Village have largely curtailed flood impacts over the years, but yards, garages, and foundations along Golden Hind Passage in Mariner Cove flood during king tides, and sometimes pumping is required for drainage. Flood tides also overtop the banks on the west side of San Clemente Creek and flow to the storage pond at the Marina Village Pump Station.¹¹¹ Muzzi Marsh and Marta's Marsh to the north, and the Triangle Marsh to the east provide flood mitigation and valuable wildlife habitat for numerous species, including special-status species such as the Ridgway's rail (*Rallus obsoletus*).

The specific vulnerabilities in this area include marsh edge erosion, near-term flooding of back yards along Golden Hind Passage, wave exposure, and the threat of overtopping of the Marina Village levee. Additional threats include rising groundwater levels driven by rising sea levels, and flooding from storm runoff. Rising groundwater driven by sea level rise will mean managing stormwater landward of the levee is likely to be an increasing challenge.

The process of developing, exploring, and refining conceptual design alternatives for these areas of the shoreline involved a variety of conversations and a broad range of input. Guided by the Town Staff, particularly the public works and planning departments, the project team worked to create different coastal protection concepts that balance the need to protect important community residents, enhance or support important ecological areas, and are cost effective. Technical and scientific input was provided by Adaptation International, the San Francisco Estuary Institute, Marin Audubon, CA Fish and Wildlife, and Miller Pacific Engineering Group. The Resilience Advisory Committee (RAC) helped refine these concepts over a series of five meetings, and the community provided comments through two community workshops, three Flood Control Board meetings, and the review of preliminary and draft materials.

As a result of these meetings and inputs, two main alternatives were developed, guided by goals outlined by the RAC. The goals of these alternatives were: (1) to use nature based measures as much as possible; and (2) to maintain current land uses as long as possible, but to bear in mind the increasing vulnerability as the century progresses.

A levee or sheet pile wall could be constructed to protect homes and residents from sea level rise and future storm and flooding events. Ideally, this would be a composite flood protection levee with integrated nature-based solutions such as a coarse beach on the bayward side of the levee to attenuate waves and reduce flood risk in Mariner Cove. Coarse beaches could also be designed to reduce marsh edge erosion at nearby Marta's and/or Triangle Marsh. Marsh mounds could provide high tide refuge for marsh wildlife as sea levels rise, and as the marshes downshift to low marsh and mudflat in the next several decades. When designing a levee, it is important to look at the low-risk tolerance sea level rise projections, consider the typical lifespan of the levee infrastructure, consider storms and provide freeboard. Putting those aspects together, the Town is considering a levee that would extend to 15ft NAVD88 (about 9 ft above current MHHW) that could be built in multiple phases to allow for settlement. Site constraints such as proximity to marsh and houses, lack of space, and poor ground conditions may limit the range of potential options. If a levee is constructed, a tide gate across San Clemente Creek would be required to complete the line of protection. It should be noted that as sea levels rise, this tide gate will need to be closed more often, resulting in loss of tidal marsh, reduced stormwater outflow, and potential water quality issues in the creek. Eventually this gate will need to be closed all the time. Tide gates and levees have finite life spans as they provide protection for a certain amount of sea level rise. However, they can be designed to be modified in the future and can reduce flood risk in the short- and medium-term while longer-term adaptation strategies are developed.

Case Study: Marsh Restoration and Levee Improvements at Tiscornia Marsh (San Rafael)

Tiscornia Marsh is located at the mouth of the San Rafael canal and owned by the Marin Audubon Society. One of the last remnants of ancient marsh in the area that has remained unaltered by human development, Tiscornia Marsh has experienced considerable erosion over the past 30 years, with approximately 3 acres lost over that period.¹¹² This erosion has resulted in significant loss of habitat for the endangered Ridgway's rail and salt marsh harvest mouse, migratory shorebirds, and other important marsh wildlife. In addition, the levee behind the marsh is relatively low, exposing parts of San Rafael's canal neighborhood to flooding during an extreme coastal storm. Erosion and flood risk will be exacerbated by sea-level rise, and the proposed restoration design addresses both concerns.

The preliminary design for a habitat restoration and sea level rise adaptation project was created by Environmental Science Associates. The project design includes ecosystem enhancements (restoring an eroded section of the existing tidal marsh, opening the diked marsh to tidal action, providing transition zone habitat) and levee enhancements (improving a section of degraded levee and enhancing public access opportunities on the Bay Trail). The next phase of the Tiscornia project is funded by a Measure AA grant to the Marin Audubon Society.

This project pilots several elements relevant to adaptation designs for Corte Madera, including the use of coarse beaches for erosion reduction at the marsh edge, an integrated plan for marsh restoration and levee enhancements, inclusion of an ecotone slope connecting the marsh and levee, and the enhancement of public access to improve the site as an asset to the community. More information about the Tiscornia Marsh restoration project is available at <http://www.tiscorniamarshp.org/>



© Douglas Mundo, Multicultural Center of Marin. Courtesy of Marin Audubon Society

Strategy: Levee/Sheet Pile Wall with Nature-Based Enhancements

Two possible alignments for a flood risk management levee/sheet pile wall and tide gate are shown in the maps to the right. There are a number of tradeoffs to consider between the inner and outer alignments. With the inner alignment, views and backyard space are impacted by the placement of the structure near more homes, while the outer alignment preserves the status quo for more properties. The tide gate location in the inner alignment disconnects less of San Clemente Creek from the Bay, with fewer corresponding ecological impacts. The location of the tide gate also determines the stormwater detention capacity of the area behind the gate, with the outer alignment offering more capacity. Because the inner alignment is constructed along the edge of the neighborhood itself, it is less likely to impact Marta's Marsh, while the outer alignment's location at the marsh edge likely means more impacts.

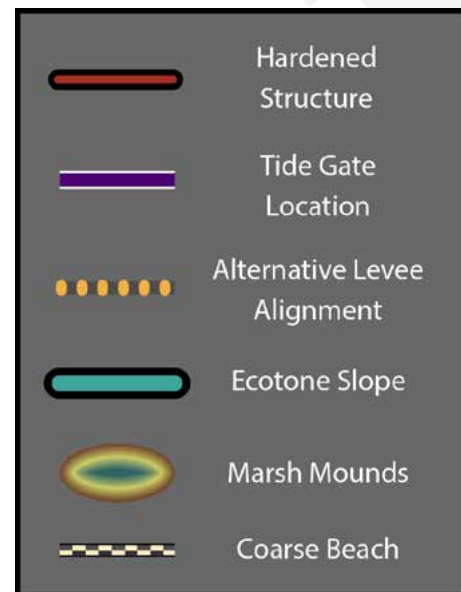

Figure 3.7. Graphic representing a potential inner levee alignment and tide gate designed to protect Mariner Cove and Marina Village.



Figure 3.8. Graphic representation of a potential outer alignment and tide gate designed to protect Mariner Cove and Marina Village.

Conceptual Cross-Section for Outer Alignment at Marina Village

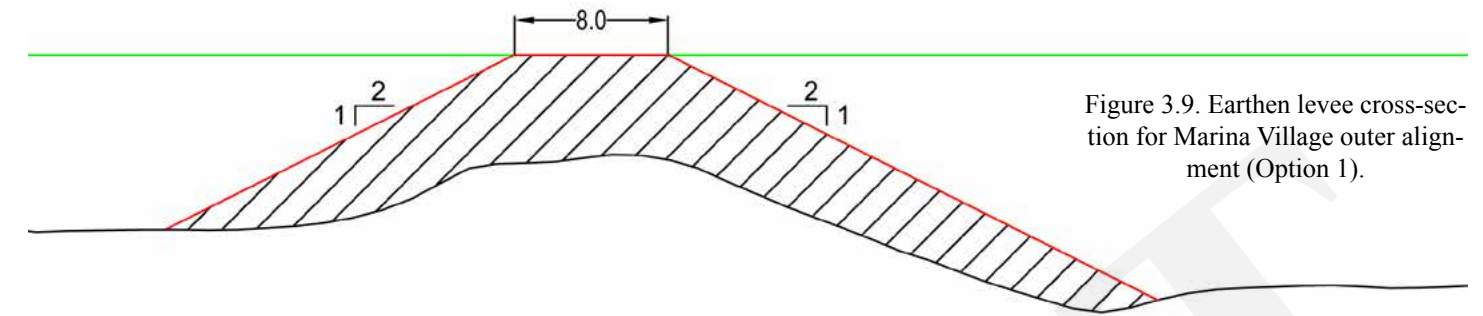

Figure 3.9. Earthen levee cross-section for Marina Village outer alignment (Option 1).

Option 1 is a traditional earthen or light weight fill levee built over the existing levee berm. The top crest width is reduced to a minimum of 8 ft. to provide access for construction and maintenance while limiting the overall size, weight, and extent of the levee. This portion of the marsh has extensive bay mud (in some places up to 110 ft. deep) that can cause significant settlement over decades and require the potential need to phase-in the initial design in order to maintain structural integrity. The 15 ft. crest elevation would need to be raised over time to keep pace with sea level rise and settlement.

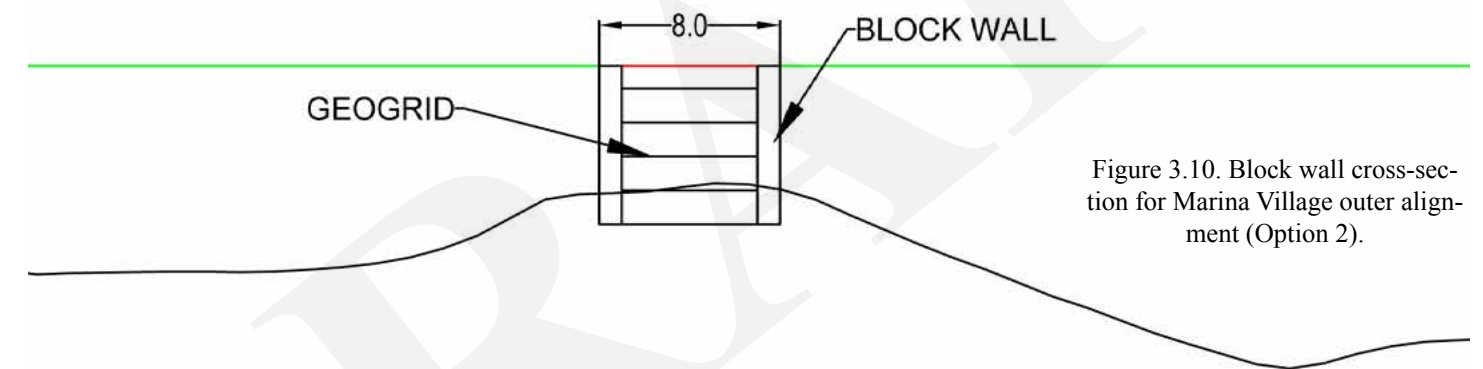

Figure 3.10. Block wall cross-section for Marina Village outer alignment (Option 2).

Option 2 is a block wall connected by a geogrid. This option would reduce additional weight on marsh, decrease settlement rates, and significantly reduce the width of the levee. The 8 ft. crest width would accommodate maintenance and potentially provide a pedestrian path. The block walls could be hidden with natural landscaping.

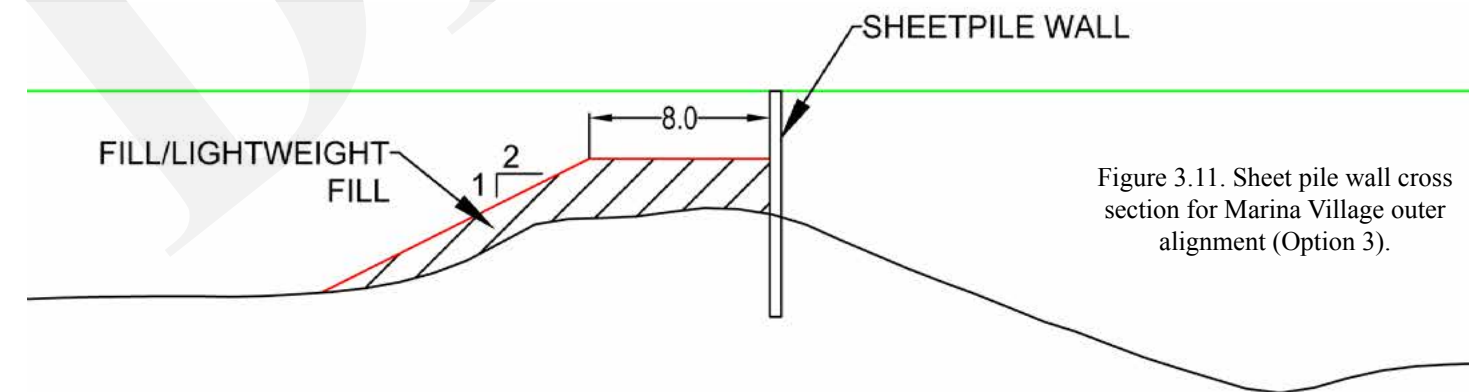

Figure 3.11. Sheet pile wall cross section for Marina Village outer alignment (Option 3).

Option 3 is a combination sheet pile wall with some additional earthen or lightweight fill for stabilization (on the Town-side of the wall). The sheetpile wall could be raised 3 feet above the top of the levee to decrease weight and associated settlement while still providing flood protection. The 8 ft. crest width is for maintenance or pedestrian access.

Conceptual Cross-Section for Inner Alignment and Mariner Cove

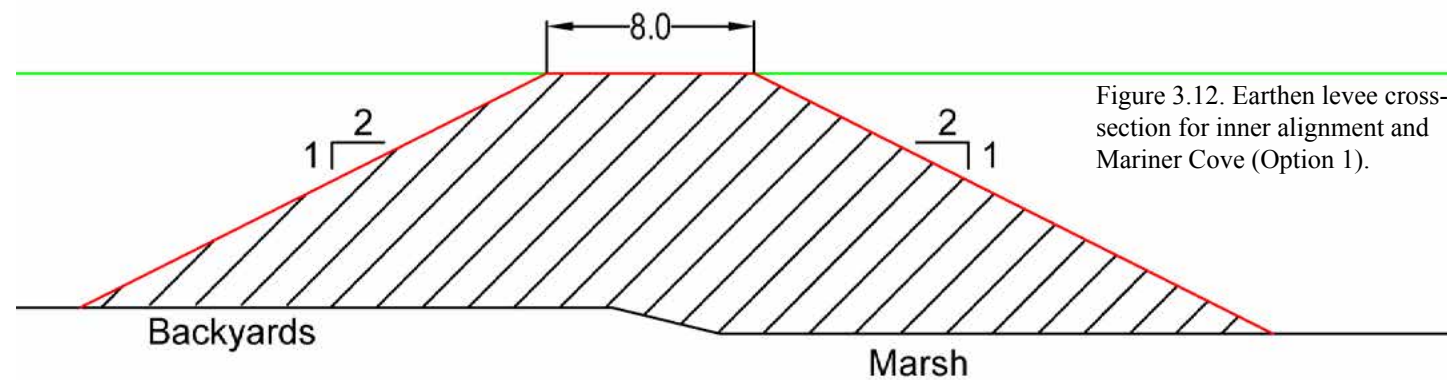

Figure 3.12. Earthen levee cross-section for inner alignment and Mariner Cove (Option 1).

Option 1 is a traditional earthen or light weight fill levee built in or near homeowners' backyards. While this is the least expensive option, it is likely infeasible due to space limitations, the net weight of the levee, and the associated settlement in areas built over bay mud.

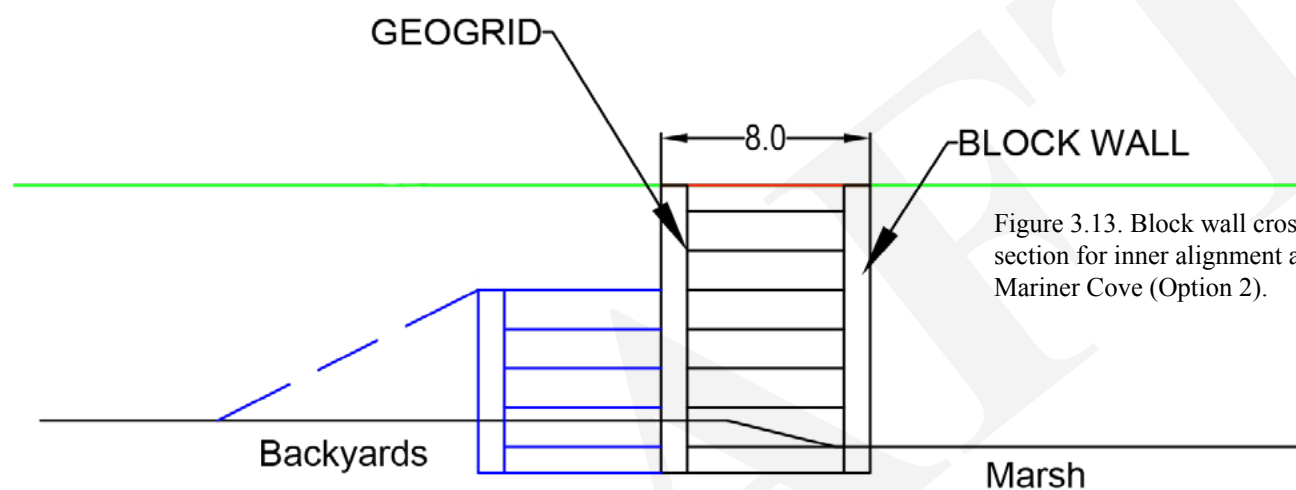

Figure 3.13. Block wall cross-section for inner alignment and Mariner Cove (Option 2).

Option 2 is a block wall connected by a geogrid. This option would reduce additional weight on marsh and significantly reduce the width of the levee; however, this option would reduce visibility of the Bay, as it would extend eight or nine feet above the current ground level to provide adequate flood protection through the middle of the century. The block walls could be modified on the inside to provide a set-up design (see blue lines in figure 3.13), be hidden by landscaping, or allow homeowners to build steps and decks connected to the wall.

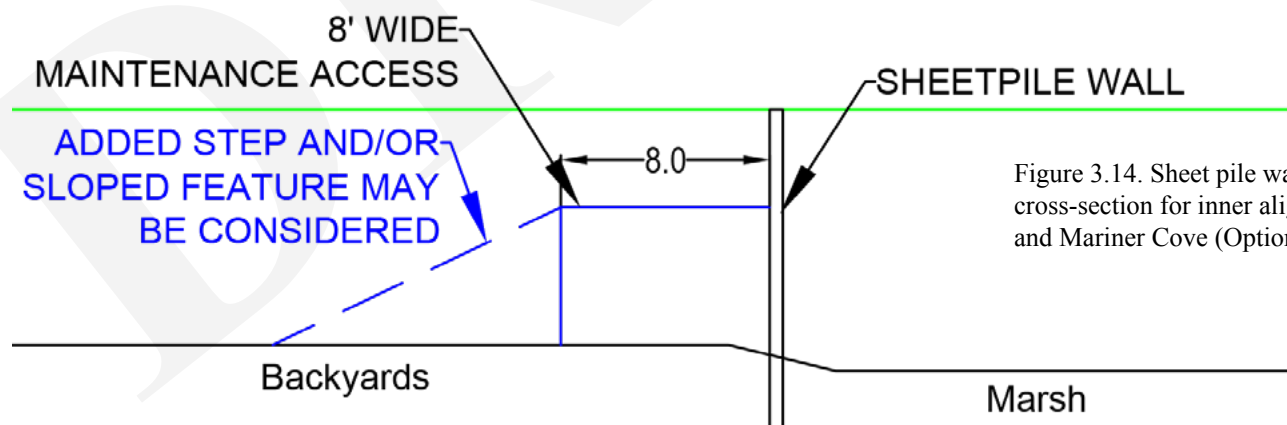

Figure 3.14. Sheet pile wall cross-section for inner alignment and Mariner Cove (Option 3).

Option 3 is a sheet pile wall. This is by far the narrowest and lightest weight option, reducing impacts to homeowners and reducing settlement. Potentially the least visually appealing, the inside of the wall could be designed with a step-up to limit visual disruption of the eight- to nine-foot tall wall, or homeowners could incorporate it into their landscaping. A coarse or composite beach (see page 73) could be placed on the bayside of the flood protection levee around Mariner Cove. The coarse beach can dissipate wave energy, help protect the vertical infrastructure, and reduce the design elevation for the wall helping to preserve views.

Tide Gate and Pump Station



Existing tide gate and pump station at Shorebird Marsh. A tide gate across San Clemente Creek would likely look different.

In order to make the levees effective as sea levels rise, a tide gate and pump station will have to be built across San Clemente Creek. Two potential locations for this tide gate are shown on figures 3.7 and 3.8 (dependent on the levee alignment). The tide gate would be designed to allow water to flow out of San Clemente creek when possible (depending on the tidal elevation) and the pump station would allow for pumping water out into the bay during high tides or storm events. While providing flood protection, the construction of a tide gate would eventually cut off the natural flow of water into and out of San Clemente Creek as sea levels rise, effectively turning the area into a stormwater detention basin. This has potential impacts on the ecology and habitat in the area.

Initial Conceptual Design Costs

Initial costs for the different levee design alternatives were developed by Miller Pacific. The preliminary costs include fill needed for each of the levee designs, alternative costs based on the type of fill and the effort required to place that fill, and costs for materials, design, and construction of the block or sheetpile walls. Additional cost considerations include design, environmental assessment, permitting, mitigation, monitoring and contingency. These numbers are for initial cost comparison only and represent a wide range due to the different types of levees that could be built. A significant amount of additional engineering, evaluation, and design work will be required to further explore the feasibility of any individual alternative.

Marina Village & Mariner Cove	
Preliminary Construction Costs	\$21.5 million
Preliminary Engineering, Public Outreach, & Environmental Document	\$1.5 million
Environmental Permitting & Mitigation	\$4.0 million
Design (15% of construction)	\$3.2 million
Construction Management (15% of construction)	\$3.2 million
Subtotal	\$33.4 million
Contingency (20% of total)	\$6.6 million
Maintenance (25 years)	\$4.0 million
Total	\$44 million

Figure 3.15. Preliminary project costs for flood protection levee and tide gate design, permitting, maintenance, and construction.

Planning for the Future

Each of the flood protection options provide the opportunity to add additional height for future protection from additional sea level rise and storm surge. While initial cost calculations are based on flood protection through mid-century (crest elevation at 15 ft. NAVD88), it is possible to adjust these design elevations higher or lower as the concepts are further evaluated; however, consideration must be taken for settlement and structural stability. Earthen levees could be elevated by placing additional fill, block walls could be built straight up or tiered, sheetpile walls could be extended. Costs and timing of additional fill to account for settlement were not considered in the initial costs. It is important to consider flexibility, longer-term cost for maintenance and future flood protection when making a decisions on the final designs.

ADAPTATION PATHWAY

MARINER COVE & MARINA VILLAGE

This adaptation pathway diagram provides a visual depiction of the various decision points associated with adaptation planning for the neighborhoods, as well as a sense of how long various adaptation actions can be expected to provide protection. Continued coordination with stakeholders in the near term will help inform decisions regarding construction of a levee/sheet pile wall with a tide gate and nature-based infrastructure (coarse beach, ecotone levee) to protect the Mariner Cove and Marina Village neighborhoods. Stakeholders can also contribute to the development of the Town’s stormwater master plan and the development of a shallow groundwater monitoring program. As environmental conditions reach predetermined thresholds, (e.g. sea levels nearing “freeboard” elevation, or the safety margin included as a buffer in the design of a levee) decisions must be made about next steps. For example, replenishing material on the coarse beach fronting a levee or sheet pile wall may reduce erosion for a certain amount of time, but eventually a decision needs to be made about raising the levee or moving toward a managed retreat strategy. This decision is likely to be dependent on the feasibility of continuing to manage stormwater and groundwater conditions on the landward side of the levee.

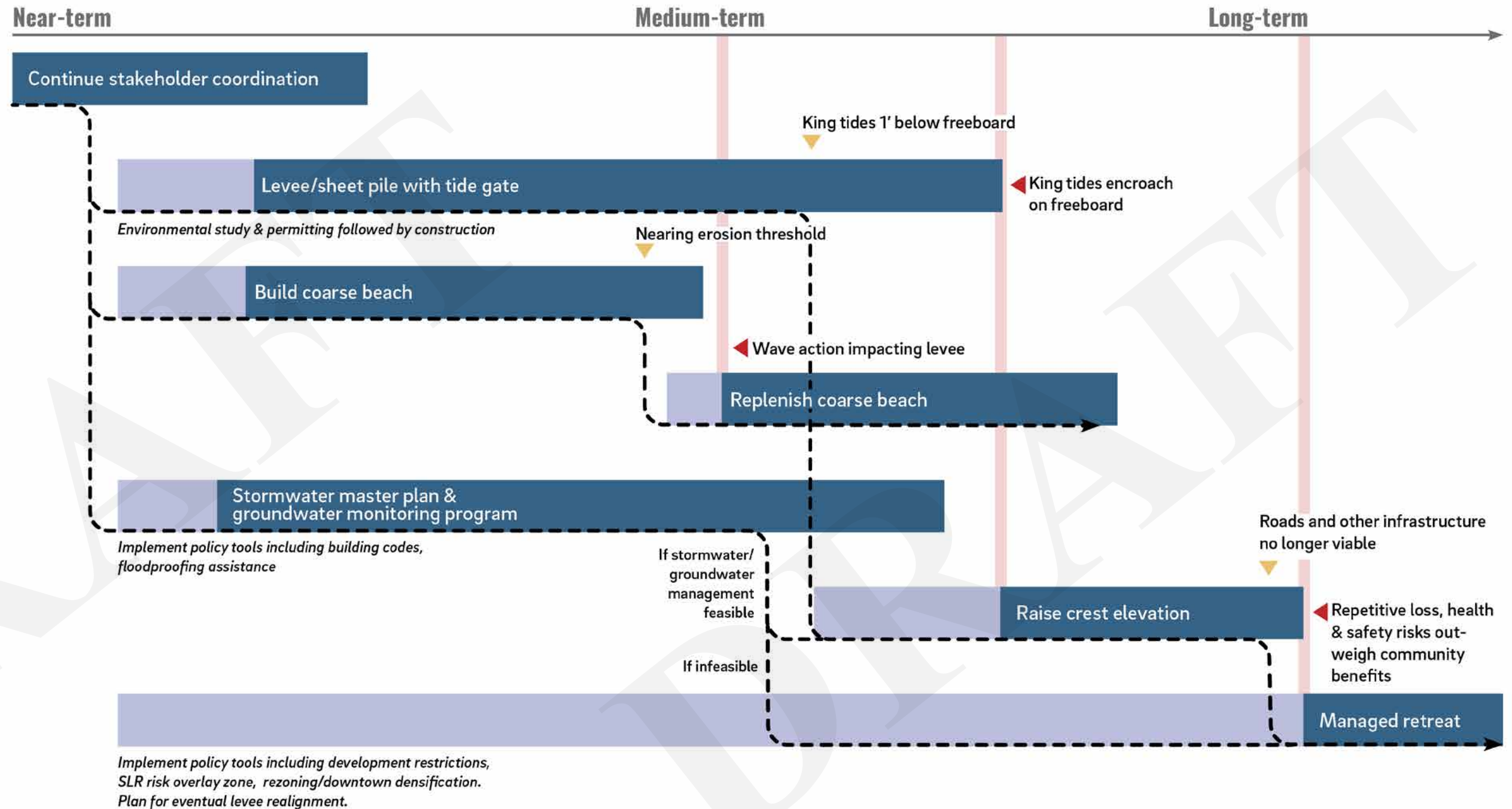

Legend

— — Potential pathway

Illustrates rough timeline and branching decision points

▼ Decision point

Measurable threshold that triggers a planning decision

■ Threshold

Measurable threshold that triggers shift to a new adaptation measure

■ Lead time

Includes stakeholder engagement, planning, design, permitting

■ Action effective; monitoring required

Timeframe of protection afforded by each adaptation option. During this period, monitoring is required to track progress toward thresholds and unexpected consequences

Figure 3.16. Adaptation pathway for Mariner Cove and Marina Village.



Corte Madera Marsh & Railroad Right of Way

Corte Madera Marsh is a unique and valuable community asset. When combined with the existing earthen levee along the current SMART right-of-way, the area provides both flood protection and critical coastal habitat for endangered species. The area is critical to the medium and long-term resilience of the community and provides an opportunity for a variety of partners to benefit from improved flood protection, enhanced habitat, and enhanced transit opportunities. Any actions to increase resilience in this area will require collaboration within and across jurisdictions.

Much of the Corte Madera baylands (including Muzzi Marsh and Marta's Marsh) were diked and filled for pastureland in the early 1900s, then later restored to tidal action. Heerdts Marsh is one of the few historical tidal marshes in the Bay that has never been cut off from tidal action by dikes.¹¹³ Today, much of the marsh is managed by the California Department of Fish and Wildlife as the Corte Madera Ecological Reserve.

The Golden Gate Bridge and Highway Transportation District (Bridge District) parcel is separated from the Bay by berms. The Bridge District has received significant amounts of fill in the form of dredged material from Corte Madera Creek and much of it is above tidal marsh elevation today. Behind the Bridge District parcel, Shorebird Marsh acts as both a refuge for waterbirds and a detention basin for stormwater flows from the Town. A tide gate connects the Shorebird Marsh to the Bay, allowing for management of water level.

Sonoma-Marin Area Rail Transit (SMART) owns a railroad right of way along the old railroad berm at the back of the marsh. The railroad berm provides flood protection as well as public access — including biking, walking, and wildlife-viewing opportunities. In the future, SMART may extend their rail line south from Larkspur along this alignment, connecting San Rafael to The Village at Corte Madera shopping center.

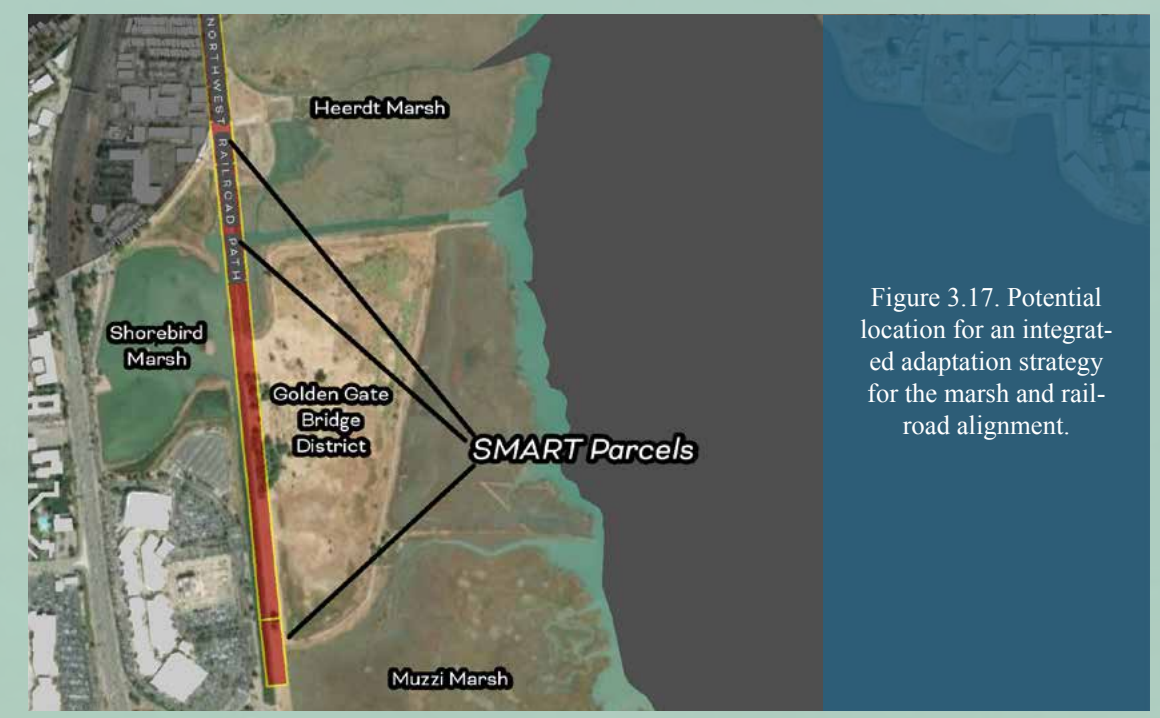
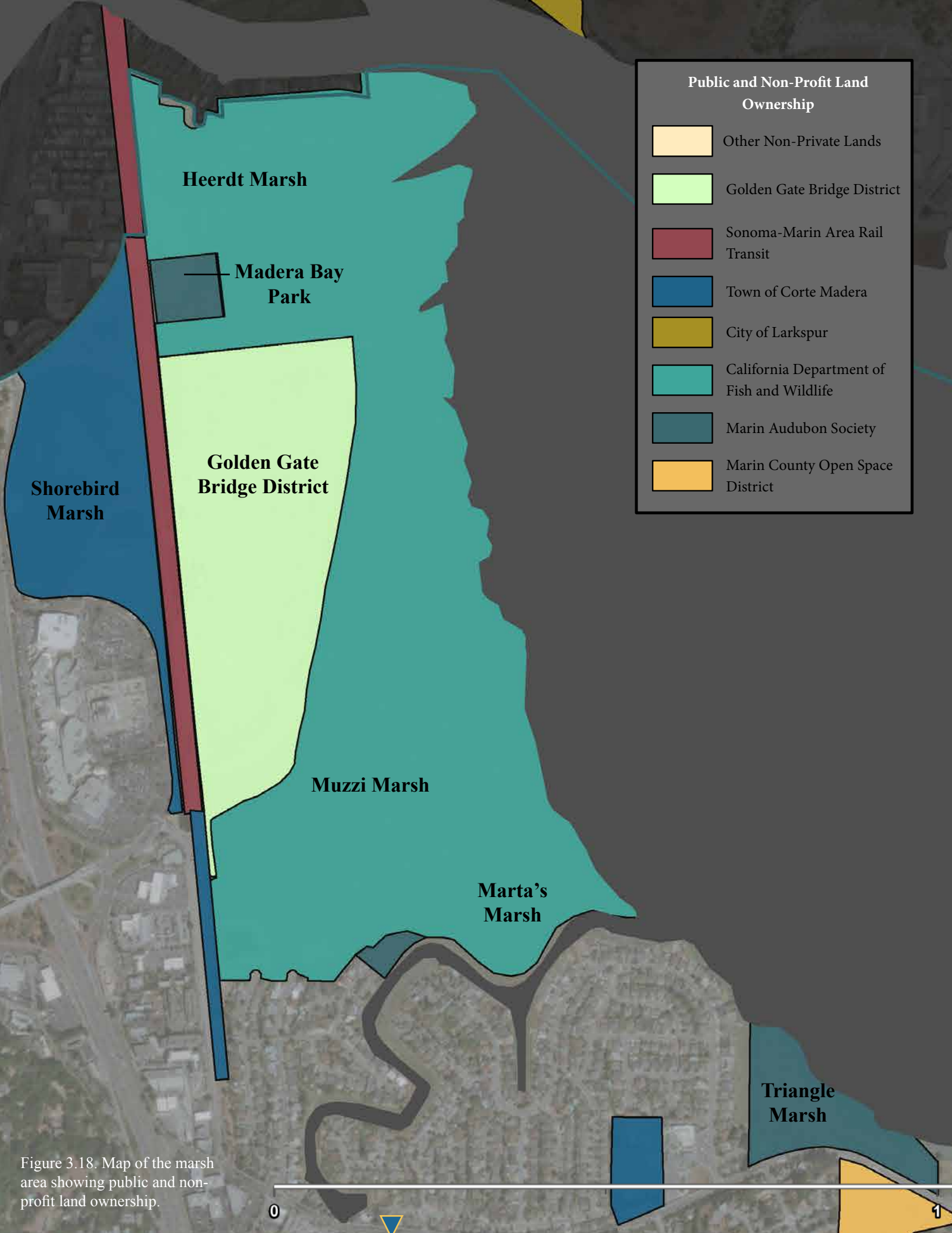

Figure 3.17. Potential location for an integrated adaptation strategy for the marsh and railroad alignment.

A king tide completely submerges Corte Madera Marsh in 2015. © Town of Corte Madera



Building Partnerships for Adaptation at Corte Madera Marsh

During April and May, 2020, the Town of Corte Madera and SFEI held a series of calls with interested partner organizations to discuss a vision for a resilient Corte Madera Marsh. All organizations were interested in participating in regional sea level rise and marsh restoration planning. Partners were also interested in providing general support to undertaking near term pilot adaptation projects while developing a long-term planning process. Such a process could include developing a regional shoreline master plan, similar to the Hayward Shoreline Master Plan. Critical partners included the following organizations:

- The **California Department of Fish and Wildlife (CDFW)** - CDFW manages most of the marsh and mudflats but has limited resources and no plans for any restoration or adaptation projects. Their focus is on managing and protecting the existing marshes, especially issues related to public access. CDFW responds to either an “immediate risk” or an “immediate need” and does not have the resources for the long-term management of new marsh restorations.
- The **San Francisco Regional Water Quality Control Board (RWQCB)** - RWQCB generally takes a long-term view on planning, looking for a net gain of ecological value. RWQCB would generally prefer the flood risk management levee encroach on the marsh as little as possible. RWQCB sees benefits in not delaying adaptation and developing a regional shoreline plan, although there was no reason some actions could not be piloted before the regional plan was complete. The RWQCB suggested that plans would benefit from an early review (10% design), by the Bay Restoration Regulatory Integration Team (BRRIT).
- The **County of Marin** - The County of Marin has interests in the Greenbrae Boardwalk and the underlying easement of the SMART alignment north of Madera Bay Park. The County is interested in helping facilitate a discussion among stakeholders about projects, such as discussions of any action in the Heerdt Marsh/Greenbrae boardwalk area, which would require a partnership among Corte Madera, Larkspur, and the County.
- The **Golden Gate Bridge, Highway, and Transportation District (GGBHTD)** - GGBHTD is focused on the restoration of a 4-acre marsh by the Shorebird Marsh channel, which is about to be constructed. Following that project, the GGBHTD is to prepare an environmental impact report (EIR) for the extension of the Larkspur Ferry Service, which will likely require the mitigation of marsh erosion due to ferry wakes.
- The **Marin Audubon Society** - The Audubon Society has recently completed the Madera Bay Park, where fill was removed to create tidal marsh habitat for the endangered Ridgway’s rail and other marsh species. The Audubon Society believes there is potential to utilize some of the remaining upland fill from this project elsewhere but does not see many opportunities, however, north of the Madera Bay Park, including Heerdt Marsh.
- The **Bay Conservation and Development Commission (BCDC)** - BCDC recently passed the “Fill for Habitat Bay Plan Amendment” - which was written with Corte Madera in mind - to place fill adjacent to existing marshes. BCDC sees this amendment was part of an adaptive management approach. They also have a keen interest in public access along the shoreline.

Figure 3.18. Map of the marsh area showing public and non-profit land ownership.



To enhance the resilience of the marsh and protect central Corte Madera from flooding, the Town is exploring a suite of adaptation actions that involve elevating the flood protection levee and investing in restoring the marsh.

Flood Protection Levee with Ecotone Slopes Along Some Segments

A raised flood risk management levee along the back of the marsh could take various forms depending on the north-south location along the existing corridor and desired design characteristics and can be combined with marsh restoration efforts. The segment of the railroad right-of-way included in this analysis is approximately 1.25 miles long and ranges from 90 to 150 feet wide. It runs between Paradise Drive and the Town border near its intersection with Industrial Way, parallel to San Clemente Drive and Redwood Hwy. At its southern end (Paradise and San Clemente Drive intersection), the right of way is 90 feet wide, nearly at grade with the surrounding land, and includes a paved bike path and a gravel walking path as part of the Bay Trail. The elevation increases towards the northern end of the corridor. North of the Clemente Drive and Redwood Highway intersection, the area is bordered on the west by a drainage channel and improved with a gravel path. Further north, the right of way widens to 150 feet, briefly interrupted by a flood control barrier with a pumping station.

The climate adaptation strategies under consideration for this corridor include new levees, improvements to existing berms, and improvements to multimodal transportation infrastructure, all of which would address sea level rise and increasing storm surge risk. As Corte Madera prepares to mitigate sea level rise near the marsh, the Town is considering flood protection alignments that follow the current alignment or are built on either side of that right-of-way. Each approach has trade offs including the optimal location, property status, required partnerships, cost, and the environmental impact of the intervention. In accordance with the 2016 Bicycle and Pedestrian plan, the Town also stands to enhance this area by considering amenities like a Class 1 bicycle facility which would offer a quieter and safer bike route parallel to the Bay Trail on Redwood Highway.

Marsh Enhancements

Recent restorations, like Marin Audubon's Madera Bay Park restoration, have continued to reshape and enhance this area of shoreline. Marsh restorations help preserve essential habitat and provide flood protection and recreational benefits for the Town. Small-scale restoration is planned for part of the Bridge District parcel, which also presents opportunities for larger-scale restoration projects. For example, the dredge spoils on the site could be moved to create an ecotone slope and enhance flood protection along the railroad berm.¹¹⁴ In the older, more pristine marshes, such as Heerdt Marsh and inner Muzzi Marsh, small marsh mounds to create high tide refuge may be a more appropriate adaptation strategy than ecotone levees, which require more fill to be placed on the marsh.

The edge of the Corte Madera marshes has eroded consistently over the last 25 years, with erosion rates averaging 0.5-2 m/yr.¹¹⁵ On the outboard edge of the marsh, coarse beaches could be placed to reduce ongoing wave erosion. A recent conceptual design for a marsh-fringing coarse beach at Muzzi Marsh suggests using large woody debris to stabilize areas of cohesive marsh that are acting as "headlands" and placing beach sediments below the marsh scarp. Over time, waves would build the coarse material into a natural beach profile, slowing erosion of the marsh scarp.¹¹⁶ This design also suggests the use of endangered plant, *Suaeda californica*, to create high tide refuge and trap sediment.

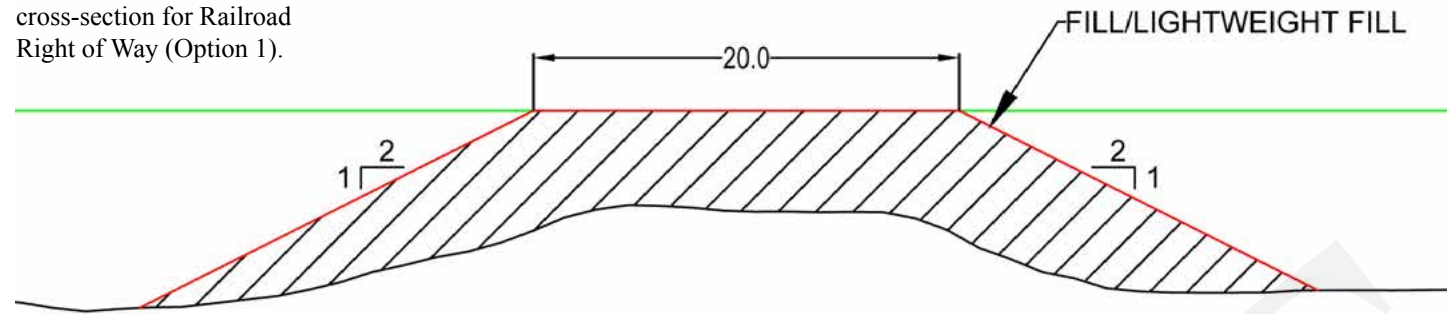

Figure 3.19. Conceptual design for potential restoration and adaptation options at Corte Madera Marsh and the railroad right-of-way.

A note about ecotone slopes: shown in teal on the map above, ecotone slopes are a way to soften the steep slope of a flood risk management levee, creating a gradient of vegetation and habitat types from tidal marsh to upland. This elevation gradient allows marsh species to seek high tide refuge above rising waters, and also provides a path (albeit a narrow one) for marshes to migrate as the seas rise. Ecotone slopes, given their gradual nature (10:1 to 20:1 slope), take up more space than a traditional 3:1 flood risk management levee. This can mean filling portions of current marsh to make way for future marsh as the climate continues to change. There is an inherent tension between conserving tidal marsh habitat for today and preserving it for tomorrow. To address this tension, we have suggested the placement of horizontal levees only in locations with degraded marsh, or on upland fill, and not in locations with high habitat value today. In this way, we can continue to pilot the concept of ecotone slopes for use as part of a flood risk management strategy without filling valuable marsh habitat. In more sensitive areas, marsh mounds can be used as an alternative strategy to attenuate some waves and provide high tide refuge.

Conceptual Cross-Section for Railroad Right of Way

Figure 3.20. Earthen levee cross-section for Railroad Right of Way (Option 1).



Option 1 is a traditional earthen levee built over the existing railroad berm. The 20 ft. wide crest at 15 ft. NAVD88 would protect the central portion of the town from a 100-year storm in the middle of the century and would provide 2 ft. of free board. It could also accommodate an enhanced bike and pedestrian path or a future rail expansion. The weight of the fill may cause differential settlement and require raising over time. Replacing earthen fill with lightweight fill would reduce settling but be approximately three times more expensive.

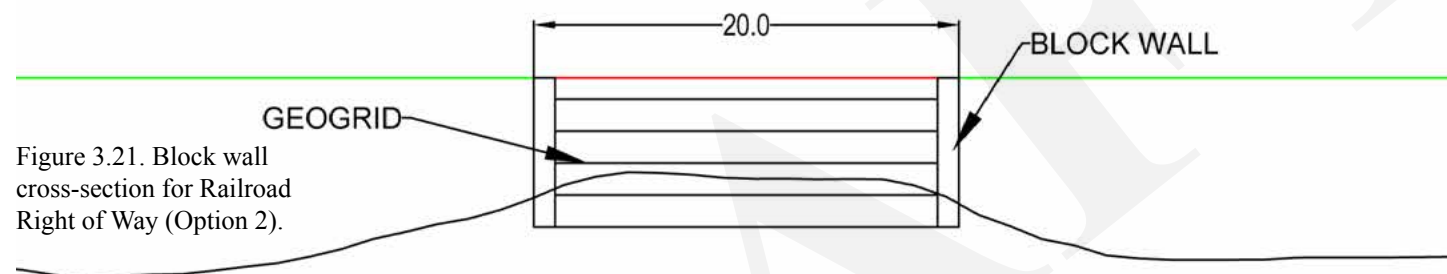

Figure 3.21. Block wall cross-section for Railroad Right of Way (Option 2).

Option 2 is a block wall connected by a geogrid. This option would reduce additional weight on the marsh and reduce settlement rates. The 20 ft. wide crest could still accommodate additional bike and pedestrian facilities or a future rail expansion. The block walls could be hidden or made more visually appealing by adding natural landscaping.

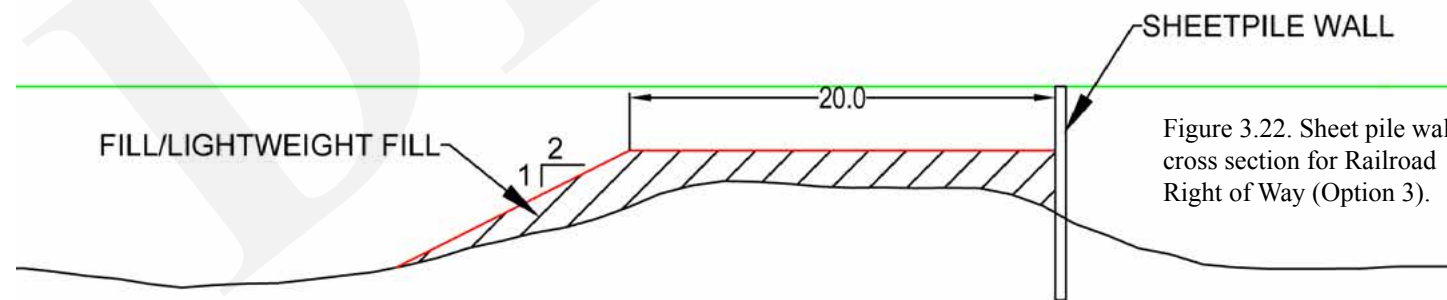

Figure 3.22. Sheet pile wall cross section for Railroad Right of Way (Option 3).

Option 3 is a combination sheet pile wall with some additional earthen or lightweight fill (on the Town side) for stabilization. The sheetpile wall could be raised 3 feet above the top of the levee to decrease weight, and significantly reduce settlement rates, while still providing flood protection. The 20 ft. wide levee crest could accommodate bike and pedestrian access or future rail.

Initial Conceptual Design Costs

Initial costs for the different levee design alternatives were developed by Miller Pacific. The preliminary costs include fill needed for each of the levee designs, alternative costs based on the type of fill and the effort required to place that fill, and costs for materials, design, and construction of the block or sheetpile walls. Additional cost considerations include design, environmental assessment, permitting, mitigation, monitoring and contingency. These numbers are for initial cost comparison only and represent a wide range due to the different types of levees that could be built. A significant amount of additional engineering, evaluation, and design work will be required to further explore the feasibility of any individual alternative.

Corte Madera Marsh & Railroad Right of Way	
Preliminary Construction Costs	\$5.0 million
Preliminary Engineering, Public Outreach, & Environmental Document	\$1.0 million
Environmental Permitting & Mitigation	\$1.5 million
Design (15% of construction)	\$0.8 million
Construction Management (15% of construction)	\$0.8 million
Subtotal	\$9.1 million
Contingency (20% of total)	\$1.8 million
Maintenance (25 years)	\$3.5 million
Total	\$14.4 million

Figure 3.23. Preliminary project costs for flood protection levee design, permitting, maintenance, and construction.

Planning for the Future

Each of the flood protection options provide the opportunity to add additional height for future protection from additional sea level rise and storm surge. While initial cost calculations are based on flood protection through mid-century (crest elevation at 15 ft. NAVD88), it is possible to adjust these design elevations higher or lower as the concepts are further evaluated; however, consideration must be taken for settlement and structural stability. Earthen levees could be elevated by placing additional fill, block walls could be built straight up or tiered, sheetpile walls could be extended. Costs and timing of additional fill to account for settlement were not considered in the initial costs. It is important to consider flexibility, longer-term cost for maintenance and future flood protection when making a decisions on the final designs.

ADAPTATION PATHWAY

CORTE MADERA MARSH & RAILROAD RIGHT-OF-WAY

This adaptation pathway diagram provides a visual depiction of the various decision points associated with adaptation planning for the marsh and railroad area, as well as a sense of how long various adaptation actions can be expected to provide protection. In the near term, a stakeholder group should be convened to coordinate planning actions between the various relevant actors (see pages 88-89). This group can oversee the coordinated development of adaptation designs for the railroad levee and marsh. Physical thresholds can be established in advance to guide the timing of key decisions and actions; for instance, marsh erosion and drowning thresholds which will be established by the Wetlands Regional Monitoring Program (WRMP) can be used to guide timing on decisions regarding the resilience of the marsh and needed interventions (e.g. replenishing coarse beach material, mudflat augmentation). Actions that enhance the resilience of the marsh will prolong the longevity of flood risk management infrastructure, but when king tides approach the freeboard elevation of the levee (the safety margin included as a buffer in levee design), a decision will need to be made to raise the levee or realign it.

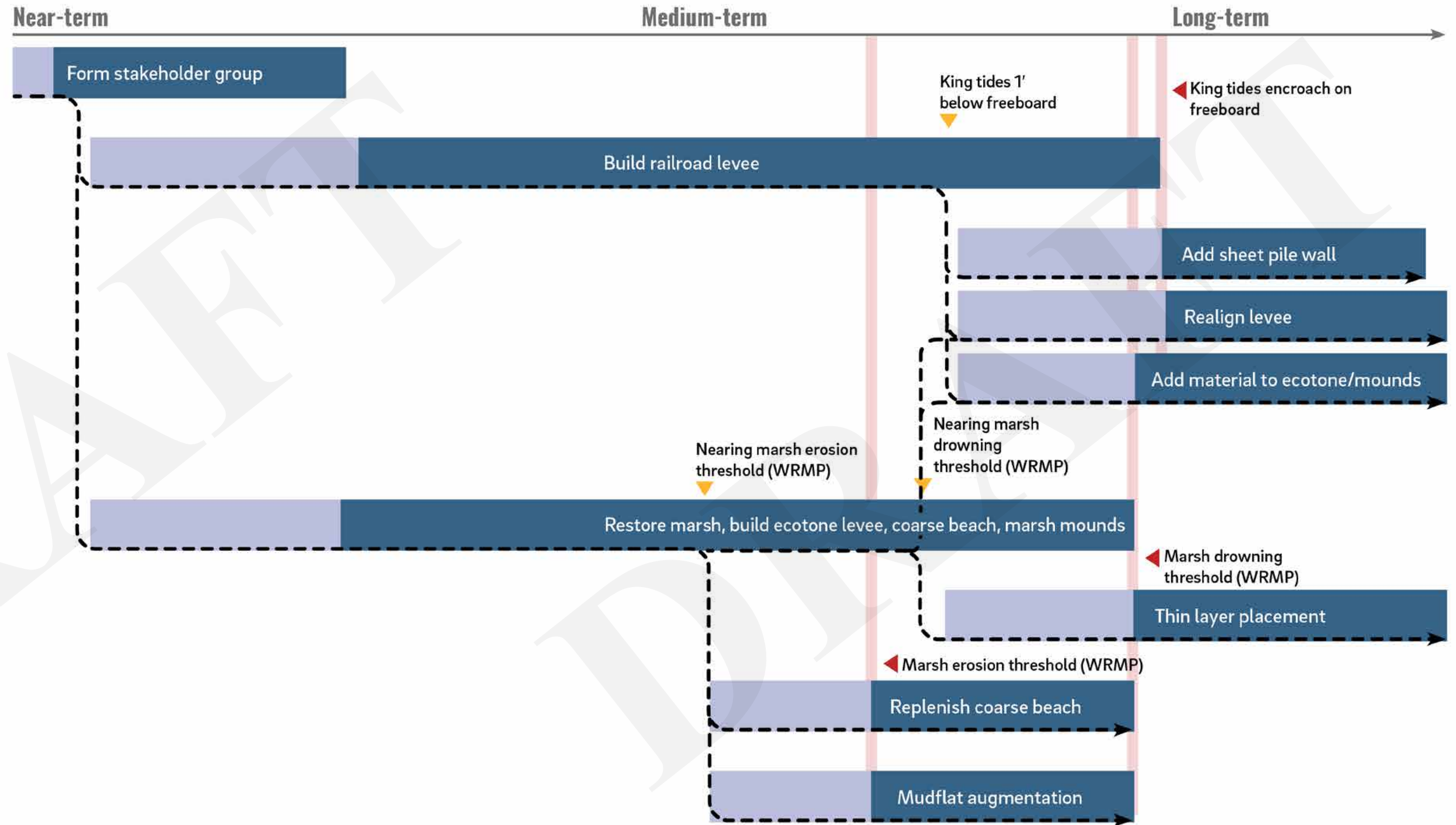

Legend

--- Potential pathway
Illustrates rough timeline and branching decision points

▼ Decision point
Measurable threshold that triggers a planning decision

| Threshold
Measurable threshold that triggers shift to a new adaptation measure

■ Lead time
Includes stakeholder engagement, planning, design, permitting

■ Action effective; monitoring required
Timeframe of protection afforded by each adaptation option. During this period, monitoring is required to track progress toward thresholds and unexpected consequences

Figure 3.24. Adaptation pathway for the Cortes Madera Marsh and Railroad Right-of-Way.



the hillsides



© Alan Durham | YouTube.com/Dropshots



Wildfires are the most immediate threat to the health and safety of Cortes Madera’s residents, employees, and visitors in the hillside neighborhoods. A significant portion of the hillside neighborhoods are wooded and lie directly within the WUI. Evacuation routes are relatively limited and steep, posing significant challenges for resident evacuation of emergency responder mobility and access. Cortes Madera is on the National Fire Plan list (managed by CalFire) of communities at high risk of damage from wildfire.¹¹⁷ Many of the homes in

these neighborhoods were built prior to present code requirements; therefore, many structures do not meet minimal standards for fire protection and safety.

Based on the Community Wildfire Protection Plan update (to be released in 2021), the Town is working to redefine its fire hazard severity zone designations based on the most up-to-date and locally-specific information available. This data indicates that 49% percent of the Town is located in the WUI.

Hillside Adaptation in Practice

No single investment will eliminate the risk of wildfire for Cortes Maderans and ongoing strategic investment in policies, programs, and infrastructure over the next ten years is going to be needed to adapt. The following four pillars serve as the guideposts for improving wildfire preparedness in Cortes Madera: 1) Evacuation; 2) Wildfire Mitigation (vegetation management, hazardous fuel reduction, and defensible space, code related infrastructure improvements); 3) Protection (fire suppression using fire fighters, fire engines, fire fighting, water systems, etc.); and, 4) Education.

* Value calculation assumes \$1.3 million average/structure and includes all areas within the Town from Zillow.





As wildfires grow hotter, bigger, less predictable, and more severe, communities are grappling with challenges of ensuring the health and safety of their residents. Evacuation planning is a crucial step in this process, and requires regional collaboration, continuous investment, and the integration of best practices from communities who have experienced catastrophic wildfires across the state. For Corte Madera, that risk is real and ever increasing.

The three hillside neighborhoods - Christmas Tree Hill, Granada Hill, and Chapman Hill - all present unique challenges in regards to evacuation. Many homes are particularly vulnerable to wildfire due to hazardous fuel conditions and limited access to major streets and evacuation routes. Hillside streets typically are wind-

ing and, in many cases, are quite narrow with as little as 12 feet of paved width before accounting for vegetation, parking, and other encroachments. In some cases, the hillside transportation network is supplemented by paths and stairways; however, existing pedestrian paths are limited, and not all paths are ADA-compliant.

In addition, there are broader regional evacuation concerns that pose additional challenges for hillside residents. Not only are there key choke points for evacuation,¹¹⁸ public transit systems are not effectively integrated into evacuation preparedness protocols and chains of command.¹¹⁹ These challenges are particularly acute for residents who live considerable distances from main evacuation routes.



FEATURED ACTIONS: EVACUATE

Enhance wayfinding (i.e. new signs for roads and paths, maps, and stair lighting) in hillside neighborhoods to support effective evacuation.

Project

Lead: Corte Madera Public Works

Chapman Hill and Granada Hill neighborhoods both lack adequate paths, signs, and lighting necessary for residents to evacuate from a wildfire by walking or biking as a last resort. Christmas Tree Hill contains several pedestrian paths and stairways that provide connections for people who are able to walk up and down the hill; however, the connections with stairways are not ADA-compliant, and some paths with steep slopes also present accessibility challenges. Wayfinding signs should include consistent, well-lit, and easy to read evacuation instructions and maps.

Enhance hillside transportation network capacity and connections where possible.

Project

Lead: Corte Madera Public Works

To enable safe and quick movement of people, the network of streets and off-street paths must be robust and, provide multiple downhill, overhill, and multimodal access and egress. Every resident should have the ability to get away from threats and authorities and emergency personnel should have access to respond to emergencies. It is critical that key evacuation choke points are addressed in the Town, Marin County, and the North Bay region, including those in Christmas Tree Hill, Chapman Hill, Granada Hill, and Sausalito Avenue (aka Hidden Valley).¹²⁰ To see specific choke points in the Town, reference pages 104-109.

On November 8, 2018, the Camp Fire - which became one of the deadliest fires in California history - burned the majority of homes in the Town of Paradise, killing 85 people. As a part of their official Recovery Plan (2019), the Town of Paradise indicated the need to address key choke points, enhance roadway widths, and ensure that all local roads can serve as either a primary or secondary ingress or egress route. In addition, the Town indicated a need to setback trees and eliminate utility poles that can burn and block egress on private and public roads.¹²¹ To the extent possible, Corte Madera should begin this work to ensure it can evacuate residents safely from hillside neighborhoods in the case of a similar disaster.

Enhance traffic congestion controls and parking enforcement along evacuation routes.

Policy and Program

Lead: Central Marin Fire Department and Town Law Enforcement

In order to improve access and egress in the hillside neighborhoods, policies and enforcement need to accompany strategic investments in the hillside transportation infrastructure. For example, law enforcement could expand ticketing of cars that are parked illegally on specified streets. Additional no-parking zones could be created and painted on hillside streets to ensure compliance.

Develop policies that further restrict development in the WUI.

Policy

Lead: TBD

The first step in reducing wildfire risk is to limit development directly in harm’s way. Currently, there is a very little opportunity to continue to develop land in the hillside neighborhoods, but reducing the expansion of Accessory Dwelling Units (ADU’s) in the WUI will help reduce the number of people in highly vulnerable areas and help make evacuation more efficient. It may also be possible to develop policies for responsible expansion of ADUs.

Identify opportunities to support Neighborhood Response Groups (NRGs) to increase community and neighborhood cohesion so communities can do more to help themselves during and after fires.

Program

Lead: TBD

NRGs are essential community support networks that already dedicate a significant amount of time and energy to supporting wildfire preparedness in the Town. The Town could enhance collaboration with the NRGs to make sure they have the tools, knowledge, and resources to support each other during an emergency. This includes providing evacuation training and drills using large-scale, unpredictable, and challenging scenarios and hosting “build an emergency kit” day and other events where community members can come together, learn about resilience, and build an emergency preparedness kit, and more.¹²²

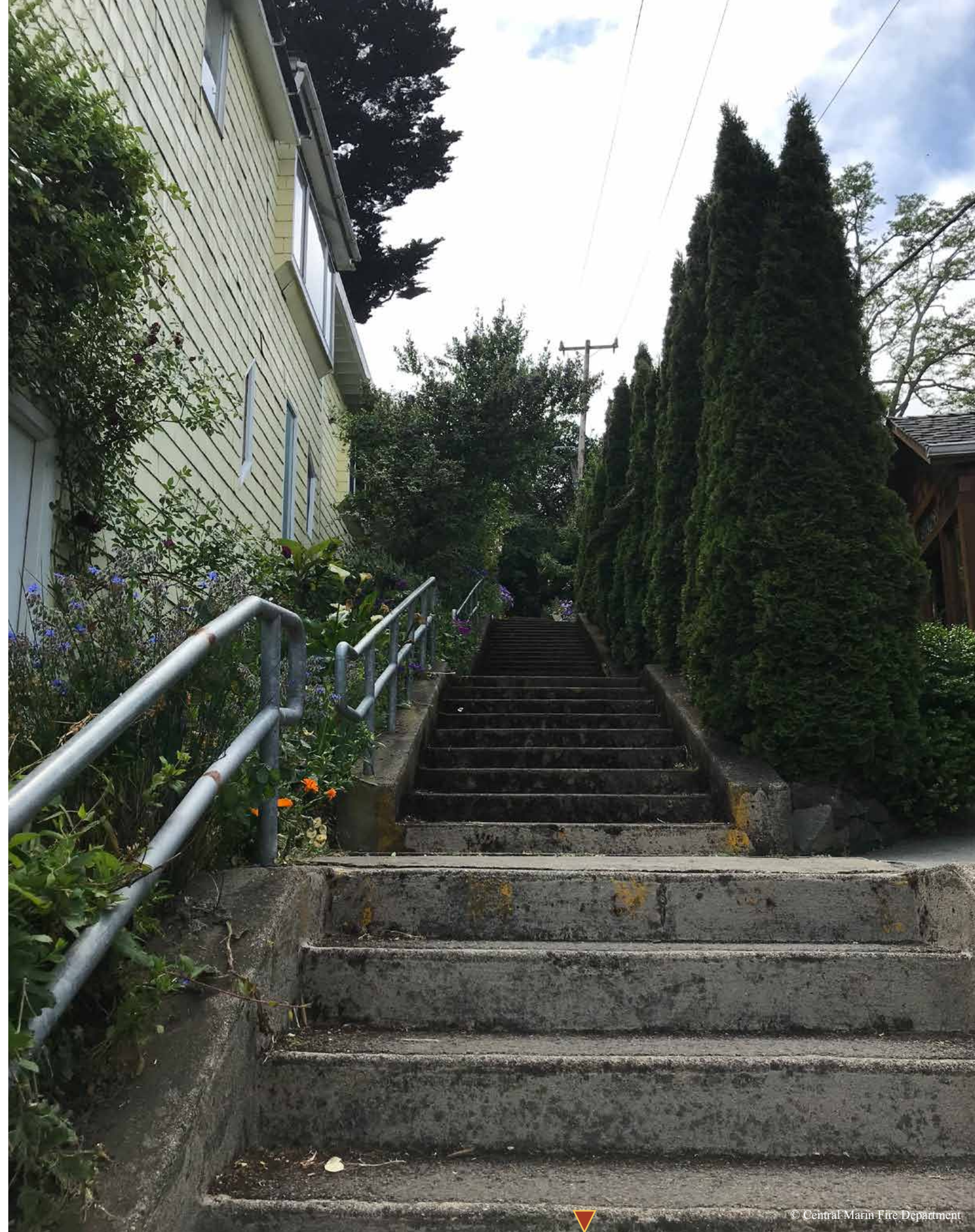

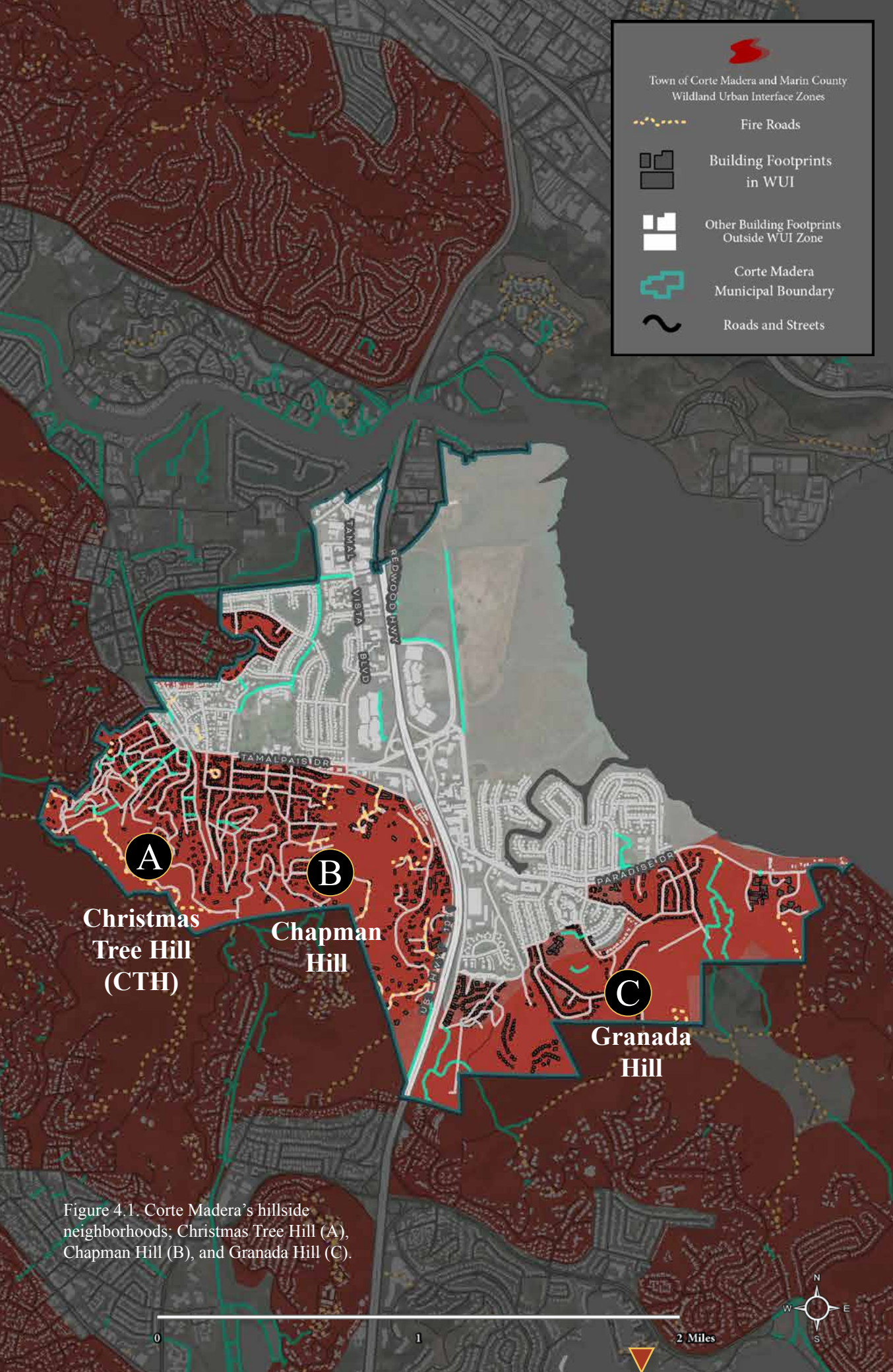

Figure 4.1. Cortes Madera's hillside neighborhoods; Christmas Tree Hill (A), Chapman Hill (B), and Granada Hill (C).

INVESTING IN INFRASTRUCTURE

The three hillside neighborhoods - Christmas Tree Hill (A), Chapman Hill (B), and Granada Hill (C) in Figure 32 - all present unique emergency response challenges, especially access and egress to and from homes near the top of the hills and away from main roadways. Within each neighborhood, streets are typically winding and, in many cases, quite narrow. There are streets with as little as 12 feet of paved width that are further narrowed by vegetation, parking, and other encroachments. Frequently, there are only one to two roads and paths connecting the neighborhoods to major roadways. There are fire roads that lead up and over the hills to neighboring jurisdictions; however, these dirt roads are steep and require improvements to accommodate private vehicles safely during an emergency. In some cases, the hillside road network is supplemented by steps, lanes, or paths; however, the existing pedestrian paths are limited and few, if any, are ADA-compliant. Bicycle facilities are very limited and public transit agencies and systems are not effectively integrated into evacuation preparedness protocols, chains of command, and regional planning efforts. Investing in transportation infrastructure changes (i.e. road widening, additional pullouts, road resurfacing) and policy changes will be important to ensure residents can evacuate safely in the case of a major wildfire.

The project team analyzed the three hillside transportation networks examining roadway widths and street connectivity. The team then evaluated adaptation alternatives based on six key metrics: 1) mode(s) of access/egress, 2) number of primary two-way roads 3) households with vehicular access/egress, 4) downhill access/egress, (the to town), 5) uphill access/egress points over hills and 6) infrastructure cost.

A. Christmas Tree Hill

The roadways on Christmas Tree Hill are the most constrained of the three hillsides, with most streets less than 20 feet wide. The most constrained segments (those less than 15 feet wide), include much of Summit Drive, upper sections of Redwood Avenue, the section of Ardmore Avenue that connects to Marina Vista Avenue, Sunrise Lane, Portola Way, and California Lane. These narrow streets limit connectivity and roadway capacity. The neighborhood does contain several pedestrian paths and stairways that provide connections for people who are able to walk up- and downhill;

however, these connections are not ADA-compliant and paths with steep slopes also present additional challenges to resident accessibility.

B. Chapman Hill

The roadways on Chapman Hill range in width: some streets are more than 20 feet wide while others are 15 and 20 feet wide, and a few are less than 15 feet. The majority of the streets that are more than 20 feet wide are located at the bottom of Chapman Hill. Buena Vista Avenue, Sausalito Street, the lower section of Chapman Drive, and the upper section of Montecito Drive also have widths greater than 20ft. The most common range of street width is 15 - 20 feet. These streets offer substantial clearance for emergency vehicles; however, they may not be as reliable due to potential obstacles that hinder seamless two-way operations. Chapman Hill Streets that are less than 15 feet wide include Prospect Lane, Templeton Court, and Alta Way, which create chokepoints for people traveling between upper Chapman Drive and Sausalito Street. Besides hilltop paths that connect to nearby fire roads, stairways, and neighboring Mill Valley streets, few pedestrian connections exist.

C. Granada Hill

Of the three hillsides, Granada Hill roadways provide the widest connections, with a majority of streets that are more than 20 feet wide. The hill's most narrow street is a connection to Granada Park and is the only street less than 15 feet wide. Unlike what can be found in Christmas Tree and Chapman Hills, all buildings along this narrow roadway have access to alternate street connections such as Prince Royal Drive. There is also far less vegetation of concern on Granada Hill in comparison to other neighborhoods, yet their wildfire risk remains high; many roadways are steep and some only offer one way in and out of an area.

The following actions are recommended starting points for investments that would improve the ability of hillside residents to evacuate before and during emergencies. These investments must be reinforced by policy-based actions, such as removing on-street parking on critical street segments, as well as infrastructure investments, such as strategically adding new connections. For more information on those policy recommendations, see pages 101-102.

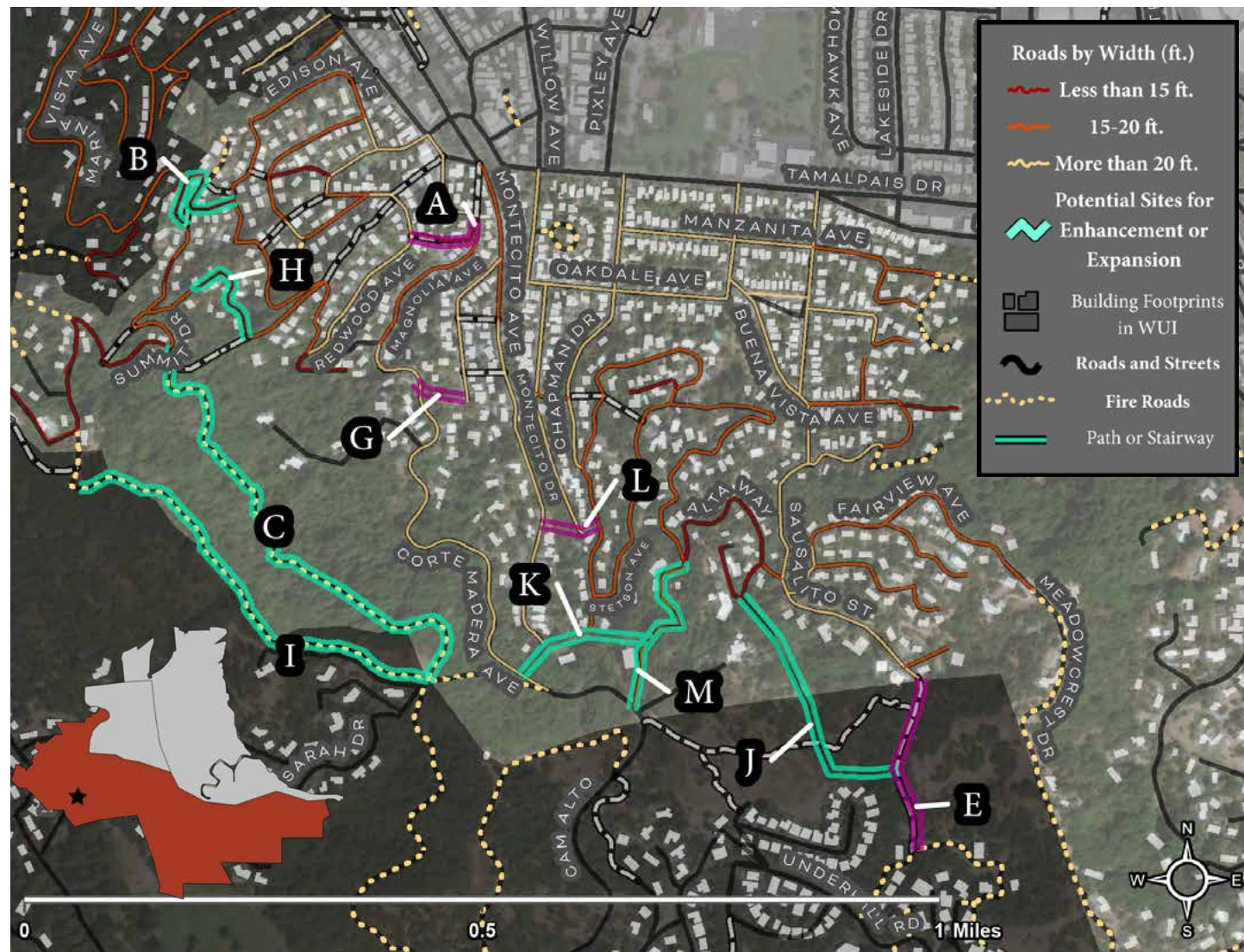

Figure 4.2. Proposed infrastructure improvements on Christmas Tree Hill and Chapman Hill.



Figure 4.3. Proposed infrastructure improvements on Granada Hill.

POTENTIAL PRIORITY ACTIONS

(A) - Enhance California Lane to connect Redwood Avenue with Corte Madera Avenue.

Neighborhood: Christmas Tree Hill
Lead: Public Works
Cost: ~\$2,000,000 (\$400,000 for design effort)

This potential connection could be used during emergency evacuations only or for everyday use and would provide 69 households with access to an additional primary vehicular access/egress route. Currently, California Lane exists as a passable street, but it is not currently publicly-owned. Enhancing this connection would require expanding the existing driveway and converting the existing stairway into a street that meets reasonable engineering standards and is at least 15 feet wide. It would likely also require regrading, some widening, and possibly retaining walls. There may be an opportunity to construct additional structural improvements on the roadway (i.e. sidewalks, drainage, etc.), which would elevate the cost of this project.

(B) - Widen and improve Summit Drive.

Neighborhood: Christmas Tree Hill
Lead: Public Works
Cost: ~\$1,000,000

Summit Drive is one of the most constrained roadways in the entire Town. Proposed improvements include street widening, resurfacing, and constructing a pullout, which will enhance this roadway and improve vehicular access/egress to 49 households.

(Multiple) - Improve the Town-maintained hill paths and stairs on Christmas Tree Hill.

Neighborhood: Christmas Tree Hill
Lead: Public Works
Cost: ~\$250,000 (~\$100,000 for design and ~\$150,000 for construction)

Beyond structural improvements, enhancements could include Potential addition of signage (including clear evacuation information, maps, and QR codes), and the installation of stair lighting and other wayfinding improvements.

(C) - Connect, resurface and improve Lower Summit fire road.

Neighborhood: Christmas Tree Hill
Lead: Public Works
Cost: ~\$2,000,000

Enhancing the connection from Lower Summit fire road to the roadway network on Christmas Tree Hill would provide additional vehicular connections to 41 households during an emergency evacuation event. This connection will require regrading to support private vehicles, as well as other safety measures and acquisition of land use rights.

(D) - Establish a connection between El Camino Drive and Madera Del Presidio Drive.

Neighborhood: Granada Hill
Lead: Public Works
Cost: ~\$150,000

Currently, a small fire lane with a paved walking trail exists between these two streets. Additional improvements to this fire lane would improve emergency access for first responders, serve as a potential egress route for residents during emergency evacuations, and provide additional recreational benefits and dedicated space for biking and walking.

(E) - Connect Sausalito Street to Mill Valley.

Neighborhood: Christmas Tree Hill
Lead: Public Works
Cost: ~\$400,000

Enhancing the connection between Sausalito Drive and Mill Valley via Coach Roach fire road would expand uphill access for private and emergency vehicles. This connection would provide almost 80 households with access to a new primary vehicle uphill route. It would require regrading and resurfacing to support private vehicles.

(Multiple) - Strategic Pullouts on Christmas Tree Hill.

Neighborhood: Christmas Tree Hill
Lead: Public Works
Cost: ~\$300,000 per pullout

There are several chokepoints on Christmas Tree Hill that would benefit from additional strategic pullouts. Right of way, topography, and road elevations present challenges for transportation projects on Christmas Tree Hill, therefore more planning and engineering work will need to be done to identify strategic locations that would improve access/egress for residents.

(G) - Improve the Grove Avenue connection.

Neighborhood: Chapman Hill
Lead: Public Works
Cost: ~\$2,000,000

A connection between Grove Avenue to Corte Madera Avenue would provide a new primary vehicular access/egress route to about 25 households during emergency evacuations. The Town would need to consider property acquisition and its associated costs to create an effective connection.

(H) - Widen Redwood Avenue where feasible on Christmas Tree Hill.

Neighborhood: Christmas Tree Hill
Lead: Public Works
Cost: ~\$1,500,000

This roadway enhancement would widen the road between Summit Drive and Morningside Drive. It provides vehicular access/egress for 35 households.



ADDITIONAL IMPORTANT ACTIONS

Though the remaining actions may have lower cost-to-benefit ratio relative to those in the higher priority tiers, these transportation network enhancements and expansions have value and should be considered. These include:

- Resurface Middle Summit Fire Road on Christmas Tree Hill (I)
- Resurface Alta Way Fire Road on Chapman Hill (J)
- Resurface Coach Road Fire Road on Chapman Hill (See Item E - Connect Sausalito to Mill Valley)
- Create a new limited access connection from Upper Chapman Drive to Corte Madera Avenue on Chapman Hill (K)
- Create a new limited access connection from Stevenson Avenue to Montecito Drive on Chapman Hill (L)
- Widen Upper Chapman Drive on Chapman Hill (M)
- Resurfacing Endeavor Fire Road on Granada Hill (N)
- Creating a new connection for the Phyllis Ellman Fire Road on Granada Hill (O)



MITIGATE

Fuel hazard reduction, vegetation management, defensible space, and home hardening in the WUI are essential to reducing wildfire risk across Corte Madera.

Fuel hazard reduction efforts (i.e. defensible space and vegetation management) require a significant amount of resources, staff, maintenance, inter- and intra-agency coordination, and policy enforcement. According to the Marin Wildfire Preparedness Grand Jury Report, “the [current] policies and procedures intended to manage and reduce vegetation [in the county] are inadequate.”¹²³ The report cites several challenges to effectively maintaining fuel hazard reduction measures in Corte Madera including vacant properties with overgrown vegetation and incomplete defensible space work, the lack of individual homeowner resources, knowledge, and engagement, and the lack of dedicated staff needed to enforce policies and ensure compliance.¹²⁴ FIRESafe Marin is one of the primary regional partners dedicated

to mitigating fire risk in the region and works in coordination with municipal and county governments, fire departments and homeowners.¹²⁵ On September 24, 2019, the County of Marin Board of Supervisors adopted a resolution formalizing the Marin Wildfire Prevention Authority (MWPA), a multi-jurisdictional joint powers authority (JPA) that dedicates \$21 million to: 1) wildfire detection and evacuation system improvements; 2) vegetation management and fire hazard reduction; 3) defensible space and home hardening evaluations; 4) public education and neighborhood wildfire preparedness; and, 5) local specific wildfire prevention efforts.¹²⁶ There are 17 agencies involved in the newly established JPA representing more than 98 percent of the land area and more than 96 percent of the residents of Marin County. The creation of the MWPA will funnel in a significant increase in investment to support the Town’s mitigation efforts.

The Rapidly Changing Wildfire Insurance Market

Across California, increasingly devastating wildfires are dramatically altering the insurability of homes. In 2018 alone, the California Department of Insurance recorded \$9 billion in lost property claims for homes lost to wildfire.¹²⁷ Additional sources indicate that in 14 months, “multiple wildfires and a mudslide killed more than 150 people, destroyed more than 30,000 homes and businesses, bankrupted California’s biggest utility and sparked more than \$30 billion in insurance claims, forcing at least one insurer to go under.”¹²⁸ Prior to 2017, standard homeowner insurance policies generally provided insurance coverage to homeowners living in the WUI. After incurring massive financial losses due to property claims, following the Camp, Tubbs, and Mendocino Complex fires, private insurers are reevaluating the market and their liabilities.

As climate change continues to exacerbate wildfire risk across the State, governments and residents are reeling from drop offs in coverage and are being required to reevaluate how they will identify coverage for their homes and businesses. In 2019 alone, “insurers dropped 235,274 policies in California, a 61% increase from 2018.”¹²⁹ In addition, premiums have continued to increase since 2015. In addition, lawmakers instituted a one year moratorium on insurance non-renewals in 2019 resulting in a temporary solution. Residents unable to recoup losses from other private insurers turn to the last-resort state insurer, FAIR California. Enrollments in the FAIR plan has increased by 225% since 2019. As the wildfire insurance market transforms across the state, lawmakers are giving this outdated mechanism increased attention over the last few years and continue to revise and address its shortcomings. The insurance landscape is changing quickly and will require continuous monitoring in order to make sure Town residents are covered in the case of a catastrophic wildfire. In some cases, completing expensive home hardening and wildfire risk reduction work did not guarantee that California residents living in fire-prone areas would qualify for wildfire insurance.



FEATURED ACTIONS: MITIGATE

In addition to wildfire mitigation projects and programs, increasing enforcement of existing policies can ensure homeowners are aware of and in compliance with WUI codes and regulations. Investments in homeowner programs are needed. These programs ensure homeowners have the tools, education, and resources necessary to conduct their own home hardening, defensible space, and vegetation management and reduce their individual wildfire risk.

Support the Marin Wildfire Prevention Authority (MWPA) to conduct individual home assessments for all homes located in the hillside.

Program

Lead: TBD

Corte Madera can play an important role in supporting the MWPA's efforts by reducing wildfire risk and improving consistent messaging for evacuation and fuel hazard reduction efforts in the hillside neighborhoods. Individual site assessments are an important part of understanding, defining, and improving compliance across the town. The MWPA recently hired a Wildfire Hazard Mitigation Specialist who will be responsible for completing county-wide home assessments, identifying homes that are not in compliance and encouraging local action.

Support 100% of Corte Madera hillside neighborhoods becoming Firewise Recognized Communities.

Program

Lead: TBD

The Firewise Recognition Program is an innovative national program that supports local wildfire preparedness goals by recognizing communities for working together on vegetation management, defensible space, and home hardening measures. While the program motivates residents to comply with local WUI codes and supports regional efforts to reduce wildfire risk, these efforts can be time-consuming and expensive to implement. Marin county leads California in the number of recognized Firewise sites (with more than 30), and leads the nation in growth of this important program - a testament to the hard work of local communities.¹³¹ Certifying 100% of hillside neighborhoods by 2022, will better prepare Corte Madera for wildfires. The Town and County will need to find ways to better support neighborhoods in this process in order to achieve this goal. Additional details on how to achieve the Firewise Certification [here](#). The steps to achieving your Firewise USA certification can be found [here](#).

Coordinate with PG&E to underground hillside neighborhood electric power lines.

Project

Lead: Corte Madera Public Works

Recent catastrophic wildfires triggered by damaged or downed power lines have led utility companies like PG&E to take temporary measures to reduce fire risk. This includes implementing Public Safety Power Shutoffs (PSPS) - regional power shut offs for residents - during Red Flag Warning days (days with low humidity levels, sustained winds above 25 MPH, wind gusts above 45 MPH, and dry fuel conditions). In order to reduce power line-induced fire ignitions and to enhance the resilience of utility infrastructure over the long-term, some municipalities (like Paradise following the Camp Fire) are working with PG&E to put power lines underground. This process, known as "undergrounding," is an expensive but successful solution at reducing powerline ignitions, particularly in high vegetation and hilly areas like Corte Madera. More information about the process the Town can take to coordinate with PG&E to start this process can be found [here](#).

Streamline the process for enforcing the Town's WUI building codes and regulations with particular attention to rental properties and absentee homeowners.

Policy

Lead: TBD

Enforcing defensible space, vegetation management, and home hardening policies is difficult, time-consuming, and expensive. This is particularly true for the dozens of vacant and rental properties located in hillside neighborhoods. Often, these homes have overgrown vegetation and are out of compliance with the Town's WUI codes. The 20-25 defensible space inspectors coordinated through the Marin Wildfire Protection Authority, set the goal of inspecting all single family homes located in hillside communities in the Town by the end of 2021. As a part of this process, the Town and FireSafe Marin could work together to support corrective action in a timely and consistent manner for properties that are found to not be in compliance with WUI codes and regulations.¹³²

Boulder County has been recognized nationally for their innovation in reducing community wildfire risk. The Boulder County Community Wildfire Protection Plan identifies best practices for integrating wildfire hazard rating systems into regional planning efforts to encourage homeowner action on fuel hazard reduction.¹³⁰ Lessons from these efforts that could be applied in Corte Madera include:

- A great deal of money, time, and effort is needed to collect, analyze, and display all the key information included in most wildfire hazard rating systems.
- Rating systems need a simple and cost effective way to be updated.
- Results of scoring systems should be made available to neighbors.
- Peer pressure is an effective motivator for residents living in the WUI.
- Homeowners who take the recommended actions need to see a corresponding change in their score

The Central Marin Fire Department is using a similar approach to assess wildfire risk and tracking which homes are in compliance with the WUI codes and regulations. For more information, see the [Community Wildfire Protection Plan](#).



Support regional partners to scale up landscape level wildfire mitigation work, especially in and near lands surrounding the Town boundaries.

Program

Lead: TBD

Several regional partners are in the process of scaling up their fuel hazard reduction work across the County but need support to adequately meet the challenge. For example, Marin Municipal Water District owns ~21,500 acres of wildland but only clears around 30 acres per year. Marin County Open Space District owns ~16,000 of wildland but only manages around 10% of lands for wildfire a year.¹³³ Regional partners should collaborate closely with the County, FIRESafe Marin, municipalities, and the MWPA through various channels including CWPP meetings, annual work plans, and plan updates to implement landscape-scale wildfire mitigation. By considering opportunities to share resources, equipment, and crews with local and County entities, wildfire risk reduction could happen more efficiently and effectively.

Update the Town’s WUI codes and regulations to include the “0-5’ non-combustible zone” or “Zone Zero” rule.

Policy

Lead: TBD

Despite having some of the most aggressive WUI codes in the nation, there are additional regulations that can reduce wildfire risk for the Town. In alignment with the state’s fire codes, the “0-5’ non-combustible zone” or “Zone Zero” policy is intended to restrict all combustible materials within 5 feet of any residential or commercial structure (including storage, debris, building materials, stacked materials, vegetation). The MWPA will serve an important role updating codes and regulations, but the Town also needs to ensure that they have the staff, resources, and time to educate homeowners and ensure compliance.

Coordinate with real estate companies, the private sector, insurance companies, and the State to create a certificate that improves resale value and insurability for homes that have complied with WUI regulations, FireSafe practices, and codes.

Program

Lead: TBD

Currently, homeowners are cited if they are out of compliance with regards to the Town’s WUI codes and regulations but there is no incentive program to encourage or recognize these investments. The Town could create a certification program for individual homeowners who comply with Corte Madera WUI codes, rules, and regulations. This work can be coordinated with home assessments already taking place through the CalFire Collector App. A certification process could help reduce wildfire risk for the entire neighborhood, increase marketability for homes in the WUI that are for sale, or increase insurability for homes. In 2014, Boulder County created a public/private partnership to “help property owners prepare for future wildfires by conducting individual site assessments with a hazard mitigation specialist, providing a customized report identifying priority risk reduction actions, offering financial rewards to subsidize costs for mitigation contractors to complete the recommended work, providing wildfire advisory contacts, and conducting follow-up inspections.”¹³⁴

Policy Consideration: Quantifying the Town’s Wildfire Risk and Expanding the WUI

Corte Madera residents must currently abide by Town,¹³⁵ County,¹³⁶ and State¹³⁷ WUI codes, most of which are based on the International Code Council.¹³⁸ The Town’s codes, which can be referenced [here](#), are updated every 3 years and the most recent update was adopted in 2020. According to data from CalFIRE, Corte Madera is entirely located in a Local Responsibility Area (LRA) and has no “very high” fire severity zones (VHFHSZ). Therefore, the State has no responsibility for fire protection or mitigation work within the Town boundaries. However, in 2008 the Town of Corte Madera adopted [Ordinance No. 904](#) expanding the VHFHSZ, pursuant to Government Code Section 51182, designating several areas within the Town as a Wildland-Urban Interface Zone (WUI) based on local findings.¹³⁹ According to the most up-to-date and localized information available at the County level, wildfire hazard severity designations are more extreme than the designations currently defined by the state. The County is in the process of updating its Community Wildfire Protection Plan (CWPP) scheduled to be published in 2021 and the plan will reflect County data and modeling that more accurately reflects the fire hazard severity designations for the Town. This information will also need to be a central part of updates to the Marin County Comprehensive (or General) Plan and the Hazard Mitigation Plan.

Expanding the WUI zone and increasing the wildfire hazard severity ratings based on new data will better represent the Town’s actual wildfire risk, increase the number of residents required to abide by Town WUI codes, and increase the Town’s competitiveness for funding necessary to support the Town’s adaptation and resilience efforts.

Specifically, extending the boundaries of areas subject to wildfire regulations in the Town will expand the number of residents required to complete vegetation management, defensible space, and home hardening work on their properties. These designations will help decision-makers better understand, assess, and develop adaptation approaches to addressing the potential impacts of wildfire for hillside neighborhoods and require additional tools, resources, and staff to enforce compliance with the codes. In coordination with the County and Town efforts to quantify wildfire risk for the Town, a thorough review is also needed on CalFire’s approach to mapping and designating wildfire hazard severity risk zones for Corte Madera.



© Ben Kuo - Unsplash.com

PROTECT

Fire protection is essential to ensuring the safety of Corte Maderans. First responders in the Town and County are dedicated and reliable specialists with a long history of supporting the region during emergencies. Yet, the impacts of climate change presents new and unexpected challenges for fire protection across the region. Wildfires are getting hotter, bigger, more severe, and less predictable. Adapting to these changes requires continuous monitoring, regional collaboration, and science-informed decision-making that incorporates best practices across the state. Limited funding, lack of staff and capacity, and antiquated policies at the state level are not commensurate with the increasingly extreme risk of wildfire. Often, local governments must rely on local knowledge and regional support to ensure that communities can adapt in this rapidly changing landscape and protect its residents. As evidenced by catastrophic wildfires across California, residents can't

rely solely on first responders to ensure that they are safe.

In addition, regional pressures continue to change the landscape for first responders across the region. As the population continues to grow in the region, the Town will need to continue to invest in its fire protection funding. The Central Marin Fire Department requires continuous monitoring and investment to make sure that it can meet fire protection demands. It will be important to scale up fire protection efforts in a way that both understands and addresses increased climate-driven wildfire risk due as well as regional development demands.

Town and County governments can no longer rely on business as usual. Regional, innovative, and long-term commitments are essential.



FEATURED ACTIONS: PROTECT

Monitor and maintain appropriate staffing levels commensurate with the current and projected emergency response environment due to climate change.

Project

Lead: TBD

As the region continues to grow, more strain is put on our local resources to make sure that our communities and first responders have the staff, capacity, and tools to keep our communities safe. In addition, as wildfires continue to grow in size, severity, and duration, planning needs to reflect the increasingly extreme environment firefighters are being tasked with managing.

Invest in new equipment and technologies that support fire suppression.

Project

Lead: TBD

As wildfires continue to grow in size, severity, and duration across the state, Town and regional planning must continue to invest in the technology and equipment that keep our firefighters, first responders, and community safe.

Build wildfire resilience stations in the WUI that have the tools necessary for first responders or trained members of the NRG's to contribute to fire suppression efforts when needed.

Project

Lead: TBD

Communities like Oakland Hills have started providing their neighborhood response groups with the resources, tools, and knowledge to fight fires if first responders are delayed, blocked, or unavailable. This includes placing fire resistant sheds throughout the neighborhoods with the tools (hoses and tools) to access fire hydrants.

Deploy more fire detection cameras in priority areas.

Project

Lead: TBD

Six fire detection cameras already monitor fire starts in the region. There are also larger camera networks that help identify wildfires when they start. For example, the Alert Wildfire Network, which is a consortium of three universities - The University of Nevada Reno (UNR), University of California San Diego (UCSD), and the University of Oregon (UO) - provides access to their network of fire and tools to improve fire ignitions, scale up fire resources and response, and monitor fire behavior. Additional information can be found [here](#).



EDUCATE

Actively engaging with and educating Corte Madera residents living in the hillside neighborhoods is essential to the health and safety of all Corte Maderans. Living in the Wildland Urban Interface is a great responsibility. It requires the knowledge, capacity, and resources in order to ensure that your home, the homes of those around you, and the lives of first responders are safe during an emergency.

Supporting the Town's regional partners to enhance wildfire preparedness education for Corte Maderan residents is essential. Ensuring that hillside residents have access to, engage with, and integrate best practices for wildfire preparedness, defensible space, home

hardening, and vegetation management are a central component in reducing wildfire risk for the Town. It is equally important that all Corte Maderans understand where to get reliable, clear, and locally-specific information related to wildfires, evacuation protocols, and other procedures.

The following education-focused actions are intended to clarify Corte Madera's role in supporting regional wildfire preparedness education efforts that provide residents the tools, education, and resources necessary to understand the roles and responsibilities of living in the WUI.



FEATURED ACTIONS: EDUCATE

Coordinate with FIRESafe Marin to integrate climate change and wildfire projections into all current educational materials and programs.

Project

Lead: Central Marin Fire Department

The current Marin County Community Wildfire Protection Plan (CWPP), published in 2017, only minimally addressed climate change and its impact wildfires in the region. Updated every five years, the Central Marin Fire Department is expected to adopt a revised CWPP in 2021. Defining the role that climate change plays in exacerbating wildfire risk is key to understanding what is at stake and implementing actions that support the adaptation and resilience efforts.

Support regional partners (i.e. FIRESafe Marin, MWPA, etc.) in the efforts to effectively educate residents about defensible space, vegetation management, and home hardening efforts.

Project

Lead: TBD

In order to ensure an efficient, effective, and consistent approach to wildfire risk reduction for the Town, strong regulations must be balanced by consistent, clear, and reliable education and outreach with Town residents. This includes consistent messaging using workshops, webinars, forums, door-to-door site visits, educational materials, and more. According to the Marin County Civil Grand Jury Report, the most effective method of educating residents about wildfire preparedness was in neighborhoods on the ground from person to person by education specialists (not firefighters).¹⁴⁰

Coordinate with FIRESafe Marin to enhance community outreach and education programs about the impacts of wildfires and smoke on physical and mental health.

Program

Lead: TBD

Wildfires not only directly impact our physical health and safety, they also impact our mental health. In addition, the impacts of smoke can be long-lasting, particularly for frontline community members. Supporting regional education partners like FIRESafe Marin is an important step in ensuring that Corte Madera residents understand and prepare for the impacts of smoke and wildfires on their physical and mental health.

Taking the Long View on Community Resilience - Pre-Disaster Recovery Planning

As the State of California experiences another year marked by record wildfires, the Town of Corte Madera has an important opportunity to learn from the experiences of other communities. Investing in existing and new resilience programs, policies, and projects that support evacuation and reduce wildfire risk over the next ten years will significantly enhance the Town's ability to respond to, and protect its residents from wildfire.

The Town should create the framework NOW that will help it rebuild better if a wildfire were to occur in Corte Madera.

Adaptation planning requires that we look at all possible scenarios when considering the impacts of disasters on our communities. As fires continue to break records in size, frequency, and severity across the State, it would be short-sighted to overlook the real, immediate, and severe threat to the health and safety of Corte Maderans. Following any disaster (like a catastrophic wildfire), residents are eager to rebuild and restart their lives and it is no time to be deciding where, when, and how to rebuild. Community preparedness and pre-disaster recovery planning decisions should be made in advance and consider community and landscape needs.

In addition, decision-makers should consider short, intermediate, and long-term implications for disaster recovery. The Federal Emergency Management Agency (FEMA), provides several resources that support multiple scales of rebuilding (the National Response Framework and the National Disaster Recovery Framework).¹⁴¹ Determining how best to support the long-term well-being of the community, how to limit rebuilding in places that are at risk, how to balance property rights with community safety, and how to make the best and most efficient use of tax dollars are all things that should be done before a disaster. In addition to utilizing federal programs and resources, we also have an opportunity to learn from the best practices and lessons emerging from around the State as municipalities rebuild from devastating events that have changed their communities forever.

The Framework for Resilience

- **Fund, develop, and adopt a pre-disaster recovery plan.** Some communities, like Douglas County, Colorado, are investing in pre-disaster recovery plans. In 2015, the county adopted its first plan, designed to “establish the county’s comprehensive framework for managing recovery efforts following a major disaster.”¹⁴² Not only does this set the framework and foundation for tough decisions before a disaster occurs, it strengthens community partnerships, and maximizes the opportunity to enhance local resilience and risk reduction efforts into all aspects of the community’s planning.
- **Implement a buy-back program that buys land in particularly dangerous areas prone**

to wildfire to prevent residents from rebuilding there. Decision-makers in Santa Rosa are considering innovative approaches to rebuilding. Certain geographic areas are considered so dangerous and prone to recurring catastrophic wildfire that some decision-makers are weighing the actual cost of purchasing that land with the long-term cost of defending the homes. Not only are leaders calling for programs that compensate property owners to not rebuild, they are also encouraging economic pressures that disincentivize them from building in these dangerous areas in the first place.

- **Consider a “three strike” rule that only allows residents to use recovery funds to rebuild their homes two times before being bought out.** In some places, like Santa Rosa, California, decision-makers have considered policies and codes that limit the number of times a resident can rebuild using tax dollars or recovery funds after a wildfire before they are no longer competitive for that funding.
- **Rebuild utility infrastructure that is safer, more sustainable, and more resilient.** Many communities across California are coordinating with regional utilities to underground all utility lines to reduce wildfire ignitions. Undergrounding utilities can be extremely expensive, especially in areas that are already built. But undergrounding utility or telecommunications infrastructure while rebuilding can limit the risk of those lines being damaged or causing wildfires during extreme weather events and enhance the resilience of the Town. The Town of Paradise created a formalized agreement with PG&E to directly underground all utility lines in order to reduce wildfire risk for the community.
- **Limit the size of homes and restrict the development of ADU’s in the WUI.** By limiting the size of homes being rebuilt in the WUI (as well as the development of ADU’s), decision-makers can limit the number of people living in the WUI. This relieves pressure on limited transportation networks and on first-responders responsible for ensuring the safety of residents during a wildfire.
- **Require residents to rebuild in accordance with Town WUI codes.** Paradise, CA developed fire resistant design standards that exceeded State, County, and Town WUI requirements. They also formalized a plan to ensure the Town can enforce defensible space codes. Examples of fire resistant design standards include: requiring gutters to be non-combustible (gutters clog with dry vegetation and fuel fires); banning the use of flammable building materials (i.e. retaining walls made from railroad ties); requiring homes to be built with sprinklers, have at least double-paned windows; and have fire-resistant siding; and, requiring homeowners to clear 100’ of defensible space around homes including a “0-5’ non-combustible zone” rule (including no mulch, flammable plants, non-pressure treated decks and wooden fences). In the case of the “0-5’ non-combustible rule,” this enables the Town to “stipulate how the local government might enforce the requirement, which the state code does not do. It also allows Paradise to add nuance to the code.”¹⁴³
- **Ensure every neighborhood has multiple access and egress routes that meet best practice standards for evacuation.** To rebuild, Paradise established a policy that requires two means of access/egress for long dead-end streets and established standards for a safe length/number of homes per street. In addition, they are identifying and building additional road segments that are missing in the transportation network in order to improve road circulation and evacuation options. This also includes limiting long dead-end streets/driveways for individual homes.
- **Require fuel break transitions for homes or neighborhoods.** Not only can landscape-scale fuel breaks between the forest and neighborhoods be extremely important for firefighters as they seek to protect a home, but additional defensible space and safety measures can also improve their safety and willingness to fight a fire in a neighborhood at risk of burning.



5
central corte madera



© iStockphoto.com



Central Corte Madera contains an array of valuable single and multi-family residences, businesses, public safety facilities, critical public infrastructure and a multi-modal transportation network. Two Central Corte Madera shopping centers, Town Center and The Village at Corte Madera, are critical to the economic health and vitality of the Town, providing much of the Town’s sales tax income. In fact, sales tax revenue accounts for about 20% of the Town’s annual net revenue (based on 2016-17 revenue calculations).^{144,145} Inland flooding from extreme precipitation events is the biggest exposure for this area, though it is also at risk of coastal flooding, wildfire, and other secondary climate impacts. Stormwater runoff has been a particular prob-

lem in some areas of the Town due to climate-induced increases in extreme precipitation, undersized storm drain pipes, inadequate drainage systems, poor inlet conditions, the lack of sufficient gradient for runoff, and land subsidence, which increase the vulnerability of low-lying areas to flooding and pooling.¹⁴⁶

In specific areas, the stormwater network is already experiencing deficiencies during extreme precipitation events. High tides can exacerbate flooding by limiting drainage into the Bay. The steep hills surrounding Corte Madera to the south and west contribute to flooding by funneling water into the central portions of town. Corte Madera Creek, which drains the Ross

Valley Watershed, and San Clemente Creek, a tidal slough draining runoff into San Francisco Bay, also contributes to flooding within the Town. In response to flooding conditions along San Clemente Creek, many residents have raised and reinforced the foundations of their homes when remodeling.

The hazards of inland flooding come not only from the water itself, but the fact that there are people, buildings, and other assets in harm’s way. One way to reduce these risks is to redesign how the town builds. In 1986 the Corte Madera Town Council established the Flood Control Board, which is responsible for advising the Town Council on all matters affecting flooding and flood protection in Corte Madera.¹⁴⁷ Ordinances addressing flood damage prevention in the Town of Corte Madera are contained in Chapter 16, Protection

of Flood Hazard Areas, of the Town’s Municipal Code. For example, most individual development projects are required to complete a detailed hydrologic study prior to Town issuance of development permits. These studies aim to identify downstream areas that experience localized flooding, detail potential impacts that proposed projects could create on these areas, and identify both on-site and off-site mitigation measures that would be required to prevent these impacts.¹⁴⁸

Flooding can also create pollution from combined sewer overflows¹⁴⁹ and roadway surface runoff to fresh and marine water systems and introduces toxins to the food chain and water supply. Further, flood-related transportation disruptions can cause significant hardship to both Corte Madera and surrounding communities.

BY THE NUMBERS

7

The number of parks located in central Corte Madera.

2

The number of fire stations in central Corte Madera.

34

The number of water pump stations located throughout Corte Madera.

242

The number of hotel rooms located in central Corte Madera.

41.4

The total miles of pipes in the stormwater system in Corte Madera.

121

The total number of retail stores located in the malls in central Corte Madera.

6,315

The total number of living units in central Corte Madera.

Central Adaptation in Practice

The suite of actions include: assessment and improvement to the Town’s drainage infrastructure;¹⁵⁰ careful planning for new developments; retrofitting, protecting and improving current infrastructure; supporting all residents, and enhancements of some planning policies. These actions generally fall into two main categories: collaboration and prevention.



© Corte Madera Memories

COLLABORATE

Central Corte Madera is located at the base of Mount Tamalpais and near the mouth of Corte Madera Creek. The steep hills surrounding Corte Madera to the south and west contribute to flooding by funneling water into the central portions of town. Corte Madera Creek, which drains the Ross Valley Watershed, and San Clemente Creek, a tidal slough draining runoff into San Francisco Bay, also contributes to flooding within the Town. In response to flooding conditions along San Clemente Creek, many residents have raised and reinforced the foundations of their homes when remodeling.

While the Town itself can do a lot to reduce local flooding, it can not tackle this issue on its own. As the recent Marin County Civil Grand Jury report on adaptation states, “Marin needs stronger collaboration among county, cities, towns, and agencies” to adapt to climate change,¹⁵¹ and this need for collaboration is readily ap-

parent in the Central portions of Town.

While there has been on-going project planning for Corte Madera creek that recognizes the need for multi-jurisdictional collaboration, more can be done to successfully reduce flooding in the area.¹⁵² Collaboration can extend beyond preparing for extreme precipitation events to enhancing partnerships to better understand and monitor groundwater, limit coastal flooding, and make efficient use of emergency management investments. The Town already benefits from a Joint Powers Authority for both police and fire protection and collaboration will be critical in both better understanding the complex set of climate and extreme weather risks for the area and developing effective solutions. Collaboration between the Town, businesses, residents, and workers require effort, but can drastically improve the success of any adaptation actions in the region.



FEATURED ACTIONS: COLLABORATE

Continue to monitor groundwater levels, and consider associated impacts in current and proposed designs for development.

Project
Lead: TBD

While there have been lots of geotechnical borings for development, there has yet to be a systematic monitoring system for tracking groundwater levels in the Town. SFEI is participating in a California Resilience Grant project to better understand groundwater levels around the Bay. Marin County is one of four counties participating in the study and the Town of Corte Madera should consider partnering with SFEI on this project.

Partner with other organizations and academic institutions to conduct studies of the impact combined riverine and coastal flooding and increased precipitation has on flood risk and vulnerability.

Project
Lead: TBD

Precipitation in the region is likely to remain extremely variable. Where that precipitation falls will largely determine where the flood waters go and who is affected. It will take detailed hydraulic modeling to better understand how the system will work with more extreme precipitation events and how different interventions can reduce or limit those impacts.

Collaborating to Limit Stormwater Pollution

The Marin County Department of Public Works/Flood Control District administers the Marin County Stormwater Pollution Prevention Program (MCSTOPPP). This is a collaborative effort by municipalities and unincorporated areas whose watersheds drain to San Francisco and San Pablo Bay. Formed in 1993, MCSTOPPP provides measures to dictate compliance with state and federal regulations, reduce or prevent stormwater pollution, and protect water quality in creeks and marshes.¹⁵³ Corte Madera has its own Urban Runoff Pollution Prevention ordinances that incorporate best management practices.¹⁵⁴



FEATURED ACTIONS: COLLABORATE

Coordinate with local/state/national agencies to create a certificate that improves resale property value and insurability for homes that have complied with flood-prevention regulations, community rating standards, and building codes.

Program

Lead: TBD

The creation of a standardized certificate that notes compliance with certain requirements could incentivize property owners to comply with stormwater management standards, floodproofing requirements, and other selected criteria. The exact use of the certification could be determined as the program is developed, and participating partners or agencies could help shape the program through development.

Collaborate with Flood Control Zone 9 advisory board, partner agencies, and municipalities within Ross Valley Flood Control Zone to align green infrastructure projects and regulations for watersheds across jurisdictions to reduce impervious hard surfaces and require integration of green infrastructure techniques into site design.

Policy

Lead: TBD

Working collaboratively to reduce impervious surfaces can effectively reduce the amount of stormwater runoff that flows into Corte Madera creek, which can inundate the Town and overwhelm the local stormwater infrastructure. Working collaboratively within the Flood Control Zone to align green infrastructure requirements makes localized action more effective at reducing flood risk.

Participate in any future discussions around creek restoration and flood mitigation in the Corte Madera Creek upper watershed.

Policy

Lead: TBD

Ross Valley is a large watershed with many players and rainfall that happens upstream can end up in Corte Madera. Continuing to collaborate or strengthening the collaboration with other jurisdictions and agencies can ensure that funding and efforts are allocated effectively to reduce riverine flooding in the region.

Study the combined impact of projected precipitation events, sea level rise, groundwater intrusion, and other flood events for the Town.

Policy

Lead: TBD

Engineering approaches to mitigating SLR-driven overland flooding usually do not address groundwater inundation, so assessment of this risk is an essential step in planning for the full impacts of climate change at local and regional scales.¹⁵⁵ Detailed groundwater monitoring efforts coupled with improved understanding of the relationship between SLR, coastal aquifers, and stormwater systems will help the Town adapt to changing conditions.

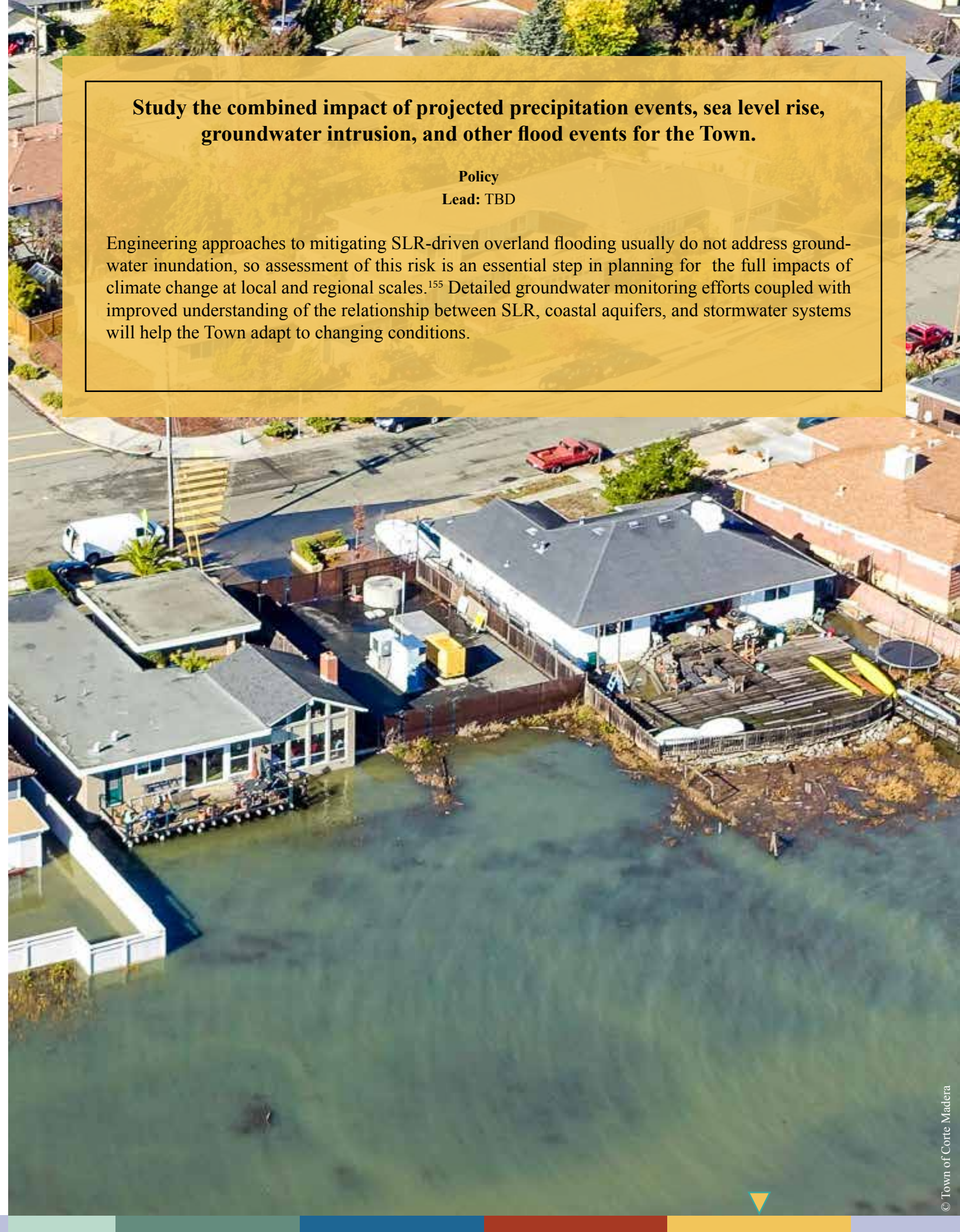

Climate, Housing, and Resilience

Corte Madera is a unique and desirable place to live. It is a great place to raise children, has good schools, great public services, and strong shared community values. In addition, the Town's natural features - the mountains, Bay, and ocean - are beautiful and provide fantastic opportunities for recreational activities like hiking, boating, and biking.

While all change can be hard, it is in many ways inevitable. Extraneous forces - like the changing economy, climate change, and globalization - are shaping the Town, region, and State. The State of California is currently facing an extreme housing shortage and is requiring communities to invest in, and develop, new housing. At the same time, climate change, global pandemics, and other economic forces are causing disruption across the country and are pushing people to move. One 2017 study indicated that around 1/3 of the people in Marin County (roughly 700,000 people) may need to move in the coming decades due to sea level rise alone.¹⁵⁶ Another study shows that "one in 12 Americans in the Southern half of the country will move toward California, the Mountain West or the Northwest over the next 45 years because of climate influences alone."^{157,158} Climate change is increasingly intensifying these challenges and will continue to be a factor in human migration patterns across the region, country,¹⁵⁹ and globe.¹⁶⁰

The Town will have to evolve, grow, and create opportunities for new development and housing. How can Corte Maderans embrace new development while designing it in a way that also enhances the resilience of the community?

As the State prioritizes local housing production goals, objective design standards can provide a streamlined and predictable review processes, and ensure that new infill development and redevelopment reflect market realities and the desired character of current residents. Key questions continue to emerge as a part of this discussion of the Town's priorities for future growth:

1. How can the Town ensure that future growth is in line with the Town's broader community goals, including sustainability, equity, resilience, and accessibility?
2. What kind of new development will help meet its goals for future growth (i.e. development location, uses, density, and design)?
3. Where, and what kind of infill and redevelopment should the Town prioritize?

By creating the framework for decision-making now, the Town can accommodate new residents (or residents who have to move out of harm's way) in ways that reduce climate risk, enhance economic vibrancy, and create affordable spaces to live, work, and play.

Nearly 90% of Corte Madera's current residential housing is single family homes and the majority of those homes are located in either a wildfire or sea level rise risk area. If the Town is going to successfully make space for Corte Maderans who may eventually need to move and also for new residents, more attention will need to be dedicated to diversifying housing opportunities and potentially creating more multi-family dwelling units.

Resilient Development

Resilient new development is situated away from high risk hazard zones, uses climate-safe building materials (in line with both the Town's WUI requirements and Sea level rise overlay zone), and provides access to multimodal transportation options. Some parts of the Town, including many hillside and waterfront neighborhoods, already have limited connections to the Town center's civic uses and to mobility options including transit, ferry, and US Highway 101. Within and near the center of Town, Tamal Vista and Tamalpais Drive are two of the town's major transportation corridors. Each has a mixture of business and residential land uses and could be targeted areas for future zoning and land use changes to support more dense mixed-use development. Planning for development at these locations will position the Town to meet future State-mandated housing production goals. In addition, there are considerable opportunities to retrofit or repurpose existing parking lots in Central Corte Madera for residential housing. Encouraging compact, mixed-use, bikeable/walkable redevelopment in these corridors can also serve the Town's climate resilience goals, while also providing diverse housing choices for current and future Corte Madera residents, increasing economic activity, and improving residents' quality of life.

Decision-makers should also consider development location and housing patterns in their land-use planning. This can have important implications for the susceptibility of a community to wildfire. For example, "leapfrog development" - low housing density and large numbers of small, isolated clusters of development that are filled in over time - is shown to have the most elevated fire risk in comparison to others.¹⁶¹

Norfolk, Virginia

In 2016, Norfolk finished its Vision2100 plan, which makes resilience part of its brand, billing itself as "the coastal community of the future." The words in its preface set the tone for the plan, stating that climate change is "not ... a dilemma, [it's] an opportunity — an opportunity to reimagine the city for the 22nd century."¹⁶²

Fundamental to Norfolk's approach is a concept called Resilient Zoning. Part of this approach allows developers to choose specific design elements from a menu of features in order to reach project approval. The Resilient Zoning concept uses a "resilience quotient," a points-based matrix that allows developers to choose from a menu of building features — ranging from green roofs to backup power systems — to reach a threshold required for project approval.¹⁶³ Norfolk's Resilient Zoning also includes a more complex initiative (though still much cheaper than armoring the coastline). This new initiative revised the zoning code to require a three-foot "free-board" (elevation of the ground floor above grade) and pervious parking surfaces in the most flood-prone areas. It also incentivizes high-density development in more flood-safe upland areas by streamlining the permit and approval processes.



PREVENT

Corte Madera faces decisions on how to most effectively invest money into retrofitting existing infrastructure or building new infrastructure to accommodate stormwater runoff. Taken holistically, the stormwater drainage system is a combination of natural assets (trees, detention ponds, creeks and canals) and hard infrastructure (storm drains, pipes, and pumps) throughout the Town. Since severe flooding closed roads and inundated storefronts in 1982, the Corte Madera has invested more than \$30 million to improve the stormwater system.¹⁶⁴

There are a number of interrelated concerns tied to stormwater in the central portion of the Town and need to be addressed for the community to successfully prepare for climate change. This includes better accommodating the extreme precipitation events that are affecting the town more and more frequently, to understanding how rising groundwater will affect hydrologic conditions across the Town.

As a bayfront community, groundwater levels in the Town fluctuate over time due to variations in rainfall,

water levels in nearby lagoons and ponds, and tides. Geotechnical investigations and borings done throughout the community indicate that groundwater levels are generally only five to 10 feet below the surface and can be as shallow as four feet after heavy rains.¹⁶⁵ When groundwater levels are high, it can seep into structures through foundations causing property damage. Geologic or hydrologic studies could identify where shallow coastal aquifers and groundwater are located as well as areas that have the potential for temporary and/or long term underground water storage.

The first step in ensuring the effectiveness of a stormwater system is to decrease peak water flows. Green infrastructure offers a suite of cost-effective solutions that can help improve the Town's resilience by managing flows and floods. Additional prevention can be done at the individual parcel level through investments in not only green infrastructure, but also by elevating buildings, roadways, and critical infrastructure above flood levels. Strategic siting of infrastructure (such as new higher density housing or new businesses) can help prevent flooding and limit impacts.



FEATURED ACTIONS: PREVENT

Promote regional efforts to analyze feasibility and effectiveness of additional green infrastructure on commercial and residential properties in mitigating stormwater runoff.

Project

Lead: TBD

Green infrastructure can reduce the strain on stormwater infrastructure by reducing the amount of water needed to be pumped to the Bay during high precipitation events. In order to determine the efficacy of additional green infrastructure, the Town needs to analyze current capacity and potential sites for additional infrastructure (see Figure 5.1). While green infrastructure cannot solve all of Corte Madera's flooding woes on its own, it is an effective flood solution when coupled with improved traditional stormwater infrastructure.

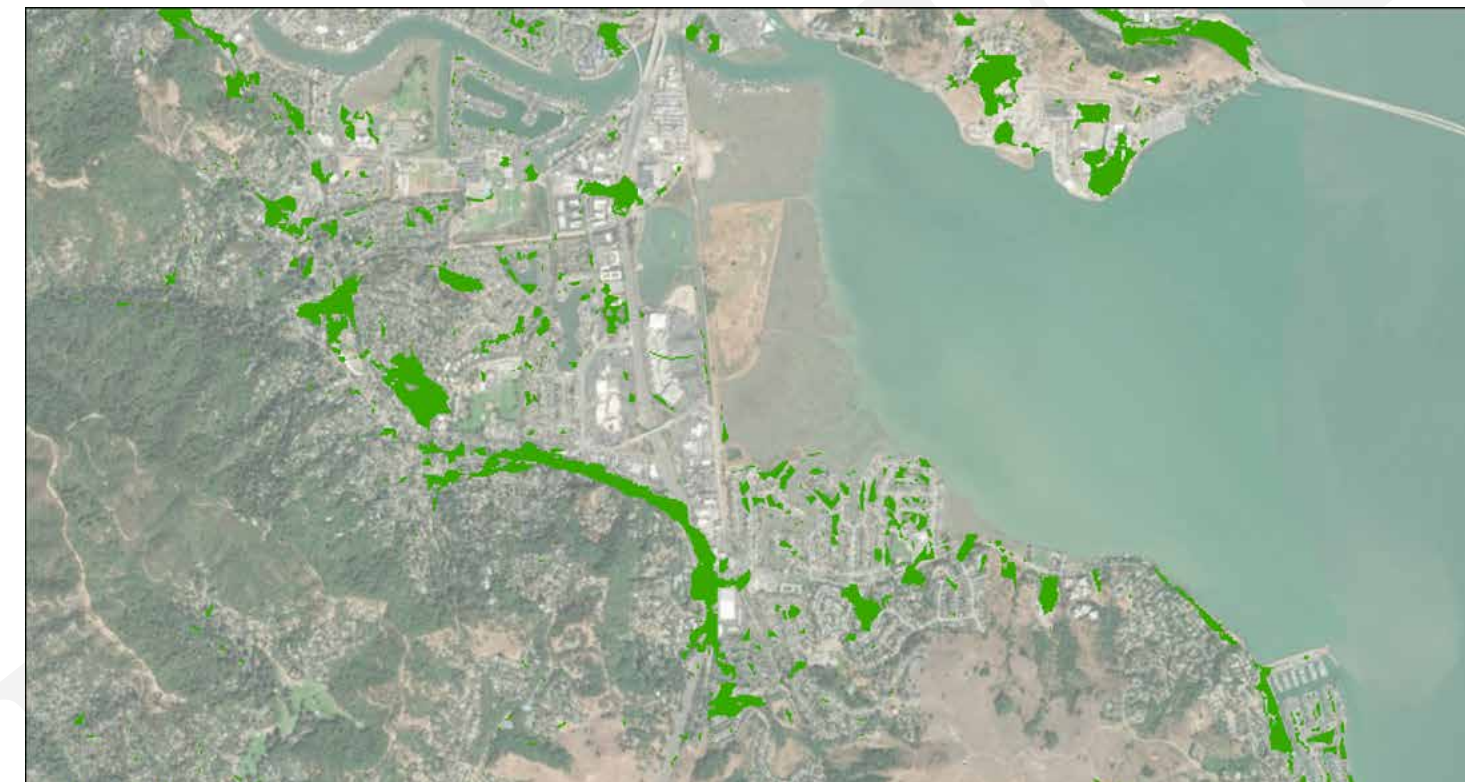

Figure 5.1. Suitable areas within Corte Madera for green infrastructure (permeable pavement, vegetated swales, or bioretention). Source: Kass et al, 2011

Address flooding issues on Casa Buena Drive.

Project

Lead: Corte Madera Department of Public Works

Subject to flooding during extreme precipitation events, Casa Buena Drive is a significant surface street for the town, connecting residential areas and small businesses to Tamalpias Drive. The first step to ensure the safety of residents and access to this section of town, is upgrading the storm drain system along the roadway to ensure that it has the capacity to handle the larger precipitation events already occurring almost annually (~\$200,000). Over the longer-term, the drive should be added to a list of important roadways to elevate to ensure functionality during extreme weather events especially as sea levels rise (~\$500,000).





Case Study: Rotterdam, The Netherlands

One of Rotterdam's 'climate-proofing' measures includes the use of rooftop greenery. The City's many flat roofs are a resource for making buildings more climate resilient, healthier, and more attractive by covering them with soil and vegetation. These green roofs absorb rainwater and down-pours have less impact on the city's storm sewers and drainage system. The green roofs, together with tree-lined infiltration zones along streets, help limit heat stress by making the city shadier and cooler. Green roofs also help insulate buildings, reducing the need for air conditioning or heating.¹⁶⁶

Provide policy incentives, such as fast-track permitting, to property owners for green infrastructure and stormwater projects that adhere to a stricter set of requirements.

Policy

Lead: TBD

Reducing the time and effort required to adhere to existing requirements incentivizes property owners to not only comply with the green infrastructure requirements, but to exceed them. The exact policy incentives can be expanded or further explored by the Town and should also include feedback from property owners as to what incentives would be most effective.

Develop a "Homeowners and Small Business Guide to Stormwater Management" to educate home and small business owners on regulations, and highlight the role that engaged residents can play to assist with community-based stormwater management.

Project

Lead: TBD

Providing homeowners and small business owners a consolidated guide on current stormwater regulations and best practices can aid in compliance. Simply informing residents and business owners of their responsibility and the role they play in reducing stormwater runoff can potentially aid in the success of reducing runoff.

Update the Storm Drainage Master Plan to include an assessment of current infrastructure and its ability to handle projected extreme precipitation and sea level rise. Effectively reevaluate the stormwater infrastructure and flood control systems.

Project

Lead: Corte Madera Public Works

It is time to invest in updating the Storm Drainage Master Plan and to specifically include an analysis of the stormwater and flood control system infrastructure capacity to accommodate increasing sea levels and runoff from heavy precipitation events.





Stormwater/Drainage Master Plan Updates

A lot has changed since Corte Madera developed a stormwater management system 50 years ago. Despite major investments in the last 20 years, climate driven heavy precipitation and stormwater continues to disrupt homes, businesses, and transportation networks.

It is time to update to the Storm Drainage Master Plan. This climate smart update will assess current system capacity and help the Town plan for and manage intensifying precipitation, stormwater, and sea level rise.

The updated Storm Drainage Master Plan will include an analysis of the Town's detention and retention basins, pumping infrastructure, pipes, and the storm drain network; it will also provide current and recommended capacities that consider climate projections.

The plan aims to identify a combination of nature-based and, where necessary, hard infrastructure solutions to upgrade the existing flood control system's capacity to handle the compounding, near- and long term impacts of larger flood events and higher sea levels. Potential strategies include:

- Analyzing current stormwater system capacity.
- Identifying desired flood protection levels in 25, 50, and 100 years.
- Identifying appropriate green, nature-based, and non-structural approaches to flood mitigation
- Upsizing pumps to effectively manage increased precipitation, runoff water levels, and water pressure.
- Assess whether dredging projects can achieve desired future flood protection levels.

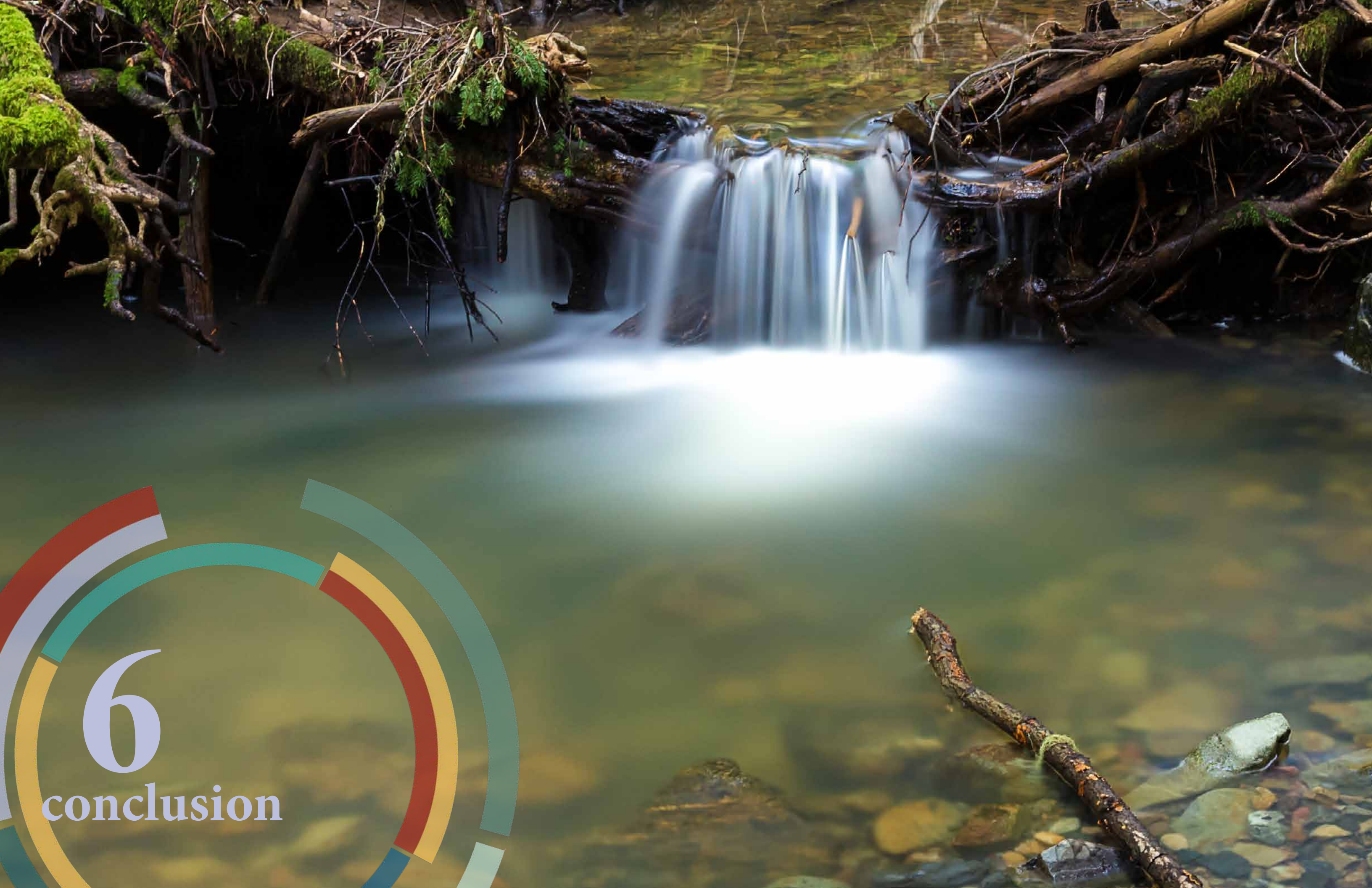

6

conclusion

Adapting to climate change is a process - not the outcome of a single project. With the completion of this adaptation plan, the Town of Corte Madera and the community have taken the next step in their journey to build resilience. Climate adaptation is, and must continue to be, a conscious process where actions are developed, refined, implemented, monitored over time and adjusted as necessary.

Resilience requires a variety of things: 1) robust and redundant systems that can withstand more intense or extreme weather events (or other stressors); 2) holistic and inclusive planning that not only considers, but incorporates, all community members in the development of effective actions; 3) monitoring and flexibility to respond to changing conditions and information over time; 4) persistence and dedication. As a key aspect of this larger climate adaptation process, this plan creates a road map that can guide the Town's investments and choices over time.

There are a number of essential first steps and near-term investments that have the potential to significantly enhance community resilience that the Town can implement now and over the next 10 years. Across the plan's four focus areas (Town-wide, Hillside, Shoreline, Central) and associated actions, there are common themes and initial investments that are clear priorities for the community.

- **Outreach/Education**

Whether it is working with the Neighborhood Resource Groups (NRGs) to enhance homeowner preparedness and home hardening efforts, initiating a program to discuss long-term shoreline resilience, or ensuring that all community members have access to and understand emergency preparedness and evacuation protocols, education is a key facet of action in each focus area. Enhancing and supporting on-going community outreach and education efforts, including incorporating discussion of climate change and deepening engagement for all community members, have a variety of benefits. These actions help ensure that Corte Maderans understand the real and serious threats facing the community, help them be better prepared for those threats, and help them be effectively involved in developing community- and neighborhood-level solutions that meet their needs and enhance resilience.

- **Collaboration**

Climate change exposures and impacts are not limited to the Town's boundaries, creating challenging, multi-faceted issues that require collaboration. Key opportunities for collaboration include: 1) working with neighboring jurisdictions and academic institutions to study the combined impact of projected precipitation, sea level rise, groundwater intrusion, and other flood events for the Town; 2) forming a regional advisory board to investigate the feasibility of managed retreat in Marin County and the region; and 3) working closely with the Marin County Parks and Open Space, the Fire District, and Marin Wildfire Prevention Authority to consider the feasibility and value of improving and opening fire roads for evacuation. From the start, these multi-jurisdictional collaborations will include essential contributors in conversations to develop and implement effective solutions that take into account all stakeholders and their concerns. These collaborations also create a strong foundation for efficient implementation of actions.

- **Infrastructure Investments**

Improving infrastructure to protect community members and property is a necessary investment. Strategic infrastructure investments can enhance community preparedness and safety as well as everyday quality of life. Some investments can be made now, while others require new or additional funding as well as time. Some essential early investments include: 1) elevating Lucky Drive to reduce the risk of flooding during king tides and extreme weather events; 2) upgrading the California Lane connection on Christmas Tree Hill for use during emergency evacuations; improving hill paths, lanes, and stairs on Christmas Tree Hill; and 3) augmenting community centers and school facilities to become Resilience Hubs that can serve as evacuation centers, cooling centers, and charging stations, during extreme heat or weather events. These investments are not inexpensive, but if pursued and strategically implemented using a mix of Town funds and outside grants,

these projects are feasible and can make a real difference in community resilience.

- **Planning and Policies**

Policies and plans are critical components of the Town's holistic approach to building resilience. They can limit or reduce current risks, lay the foundation for future actions, distribute costs, and complement infrastructure investments. An essential first step for the Town to explore is the augmentation of existing policies, (or, as necessary, the creation of new policies) to protect residents and guide future investments. Early consideration should go to policies and plans that: 1) explore a regional approach to meeting housing development goals that locates new housing areas within the County that are less vulnerable to climate hazards; 2) streamline the process for enforcing the Town's WUI building codes and regulations with particular attention to rental properties and absentee homeowners; 3) update the Stormwater Master Plan, including an analysis of current capacity and future needs under changing conditions; and 4) consider implementing a Coastal Resilience overlay zone. Additional near term planning investments include completing a detailed environmental review of the different levee alignment and design options.

Corte Madera is on the forefront of developing actions to enhance resilience, as demonstrated by the development of this proactive adaptation plan and the actions highlighted above. The Town is dedicated to working with other communities, the county, and local, regional, and state organizations to develop efficient, effective, and feasible solutions that reduce risk and enhance resilience. Leading is not always easy, and it requires weighing trade-offs and making difficult decisions about the best use of funding and investments to support the town's goals. In some cases, this will mean trying new, innovative solutions, learning from trial and error, and exploring different alternatives.

In 30-50 years, under the pressures of a changing climate, Corte Madera will look different than it does today. Actions taken now will determine if the Town is able to meet the goals detailed in this plan. The Town is dedicated, however, to preserving its identity and "small-town feel" by protecting and investing in the resilience of the people, infrastructure, and ecosystems that make the community what it is today and ensuring that Corte Madera has a thriving, vibrant, and resilient future.

endnotes

1 (Corte Madera, CA | Data USA, n.d.)
2 (Planning and Investing for a Resilient California: A Guidebook for State Agencies, 2018); EO B-30-15, 2015
3 (Planning and Investing for a Resilient California: A Guidebook for State Agencies, 2018)
4 (California Legislative Information, n.d.)
5 (Town of Corte Madera General Plan, 2009)
6 (Bill Text - SB-379 Land Use: General Plan: Safety Element., n.d.)
7 (Marin County Civil Grand Jury, 2020)
8 (California Adaptation Planning Guide, 2020)
9 (Planning and Investing for a Resilient California: A Guidebook for State Agencies, 2018)
10 (California Adaptation Planning Guide, 2020)
11 (Town of Corte Madera, 2015)
12 (Planning and Investing for a Resilient California: A Guidebook for State Agencies, 2018)
13 (Bill Text - AB-2800 Climate Change: Infrastructure Planning., n.d.)
14 (Bill Text - SB-1 California Environmental, Public Health, and Workers Defense Act of 2019., n.d.)
15 (Bill Text - SB-1000 Land Use: General Plans: Safety and Environmental Justice., n.d.)
16 (The California Environmental Justice Alliance & PlaceWorks Inc., 2017)
17 (About the Project - BayWAVE, 2020)
18 (Lacko, 2019)
19 (Marin County Multi-Jurisdictional Local Hazard Mitigation Plan, 2019)
20 (Adaptation Planning, 2020)
21 (Highway 1 Corridor In Tam Valley Transportation, n.d.)
22 (BayCAN Members' Adaptation Project Matrix, 202 C.E.)
23 See full survey questions and detailed information on responses in Appendix X.
24 (USAID, 2013)
25 (Weiland et al., 2014)
26 (USAID, 2013)
27 (California Adaptation Planning Guide, 2020)
28 San Francisco Bay Regional Report: California's Fourth Climate Change Assessment
29 (Dalton et al., 2018; Petersen, n.d.)
30 (California Adaptation Planning Guide, 2020)
31 (CAL FIRE, 2018)
32 (Rincon, 2019)
33 (Wahl et al., 2019)
34 (CAL FIRE, 2018)
35 (State Key Findings - California Climate Change Assessment, n.d.)
36 (Marin County Civil Grand Jury, 2019)
37 (State Key Findings - California Climate Change Assessment, n.d.)
38 (Marin County Multi-Jurisdictional Local Hazard Mitigation Plan, 2019)
39 (Shirzaei & Bürgmann, 2018); Personal communication with authors and examination of new subsidence rate data.
40 (National Research Council, 2012)
41 (U.S. Army Corps of Engineers, 2018)
42 (USC Sea Grant & USC Dornsife, n.d.)
43 (Rotzoll & Fletcher, 2013)
44 (Plane et al., 2019)
45 (Befus et al., 2020)
46 (Cooper et al., 1964, Freeze and Cherry, 1979, Rotzoll and Fletcher, 2013).
47 (Hoover et al., 2017)
48 (USC Sea Grant & USC Dornsife, n.d.)
49 (Ackerly et al., 2018)
50 (Cal-Adapt, n.d.)
51 (Climate Change | Caltrans, n.d.)
52 (Ackerly et al., 2018)
53 (Marin Municipal Water District, 2016a)
54 Since 2000, the longest duration of drought (D1-D4) in California lasted 376 weeks beginning on December 27, 2011 and ending on March 5th, 2019. California experienced "extreme" and "exceptional" drought beginning in late

2013 and ending in early 2017. See here for more information on current and historical drought conditions in California.

55 (AghaKouchak et al., 2018)
56 Many of California's heaviest precipitation events, called "atmospheric rivers", occur in the winter and are associated with storms generated over the Pacific Ocean.
57 (Ackerly et al., 2018)
58 (Ebi et al., 2018)
59 (OAR US EPA, 2014)
60 (Ho, 2020)
61 (Betancourt, 2020)
62 (Dodgen et al., 2016)
63 Section 502 of the Clean Water Act defines green infrastructure as "...the range of measures that use plant or soil systems, permeable pavement or other permeable surfaces or substrates, stormwater harvest and reuse, or landscaping to store, infiltrate, or evapotranspire stormwater and reduce flows to sewer systems or to surface waters."
64 (Denchak, 2019)
65 (OW US EPA, 2015b)
66 (Green Infrastructure, n.d.)
67 (OW US EPA, 2016)
68 (OW US EPA, 2015a)
69 (Marin County Civil Grand Jury, 2019)
70 (Marin County Civil Grand Jury, 2019)
71 (St. John, Serna, 2018)
72 (Wildfire Preparedness, n.d.)
73 (Marin County Civil Grand Jury, 2020)
74 (Marin County Civil Grand Jury, 2019)
75 (California Public Utilities Commission, 2020)
76 (Urban Sustainability Directors Network, 2019)
77 (Resilience Hubs, n.d.)
78 (Learn about Public Safety Power Shutoffs (PSPS), n.d.)
79 (Marin Climate & Energy Partnership, 2016)
80 (| Code of Ordinances | Corte Madera, CA | Municode Library, n.d.-a); WUI Building Codes Chapter 15.04.080
81 (Marin County Civil Grand Jury, 2020)
82 MC/MV were built on baylands in the 1950s (find citation)
83 (Town of Corte Madera General Plan, 2009); Chapter 7: Flooding and Floodplain Management)
84 (Shirzaei & Bürgmann, 2018)
85 (BCDC & ESA PWA, 2013)
86 (Underwater: Rising Seas, Chronic Floods, and the Implications for US Coastal Real Estate, 2018)
87 (California Coastal Commission, 2018)
88 (Lacko, 2019)
89 (City of Foster City, 2016)
90 (City of Foster City, 2020)
91 (Flood Protection | Corte Madera, CA - Official Website, n.d.)
92 (Grannis et al., 2011)
93 (Center for Ocean Solutions, Stanford Woods Institute for the Environment, 2018)
94 (Grannis et al., 2011)
95 (Lacko, 2019)
96 (Georgetown Climate Center, n.d.)
97 (Local Coastal Program and General Plan Update (City of Imperial Beach), n.d.)
98 (City of Imperial Beach, 2019)
99 (Bridges et al., 2015)
100 (Goals Project, 2015)
101 (SFEI & SPUR, 2019)
102 (Nur et al., 2018)
103 (SFEI & SPUR, 2019)
104 (BCDC & ESA PWA, 2013)
105 (SFEI & SPUR, 2019)
106 (Merkel, 2005)
107 (SFEI and SPUR, 2019)
108 (SFEI & Baye, 2020)
109 (SFEI & SPUR, 2019)

110 (Bridges et al., 2015)
111 (Town of Corte Madera, 2008)
112 (Marin Audubon Society, 2020)
113 (BCDC & ESA PWA, 2013)
114 (BCDC & ESA PWA, 2013)
115 (Carkin et al., 2020; SFEI & Baye, 2020)
116 (Baye, 2020)
117 (Welcome to Communities at Risk, n.d.) (Marin County Civil Grand Jury, 2019)
118 (Marin County Civil Grand Jury, 2019)
119 (Marin County Civil Grand Jury, 2019)
120 (Marin County Civil Grand Jury, 2019)
121 (Town of Paradise California, 2019)
122 (Marin County Civil Grand Jury, 2019)
123 (Marin County Civil Grand Jury, 2019; pg. 1)
124 (Marin County Civil Grand Jury, 2019)
125 (FIRESafe MARIN, Marin County California Fire Safe Council, n.d.)
126 (Office of the County Administrator, 2019)
127 (Frank, 2020)
128 (Bikales, 2020)
129 (Serna, 2020)
130 (Boulder County, 2011)
131 (Marin County Civil Grand Jury, 2019)
132 (Marin County Civil Grand Jury, 2019)
133 (Marin County Civil Grand Jury, 2019)
134 (Headwaters Economics, 2016; pg. 23)
135 (| Code of Ordinances | Corte Madera, CA | Municode Library, n.d.-b); WUI Building Codes Chapter 15.04.080)
136 (County of Marin Community Development Agency, 2017)
137 (California Building Standards Commission, n.d.)
138 (International Code Council, Inc., 2017)
139 (Ordinance No. 904, 2008) (ordinance 904)
140 (Marin County Civil Grand Jury, 2019)
141 (U.S. Dept. of Homeland Security, 2016)
142 (FEMA, 2017; pg. 3)
143 (Newberry, 2019)
144 (Table of Sales Taxes Received by Fiscal Year, n.d.)
145 (Town of Corte Madera, 2019)
146 (Town of Corte Madera, 2008)
147 (Town of Corte Madera, 2008)
148 (Town of Corte Madera, 2008)
149 (OW US EPA, 2015c)
150 As part of an update to the Town's Master Drainage Plan.
151 (Marin County Civil Grand Jury, 2020; pg. 18)
152 (A3GEO, 2019; pg. 3)
153 (A3GEO, 2019; pg. 3)
154 Municipal Stormwater Ordinance is under Title 9 of the Town's Municipal Code, Chapter 9.33, Urban Runoff Pollution Prevention Ordinance
155 (USC Sea Grant & USC Dornsife, n.d.)
156 (Hauer, 2017)
157 (Lustgarten, 2020b)
158 (Qin Fan et al (2018)
159 (Lustgarten, 2020a)
160 (Podesta, 2019)
161 (Syphard et al., 2013)
162 (Barth, 2018)
163 (Barth, 2018)
164 (Town of Corte Madera, 2014); Draft EIR Section 4.8 Hydrology and Water Quality
165 (Town of Corte Madera, 2014); Draft EIR Section 4.8 Hydrology and Water Quality
166 (Berger, 2018)



references

- 2016 City of Imperial Beach Sea Level Rise Assessment | CAKE: Climate Adaptation Knowledge Exchange. (n.d.). Retrieved October 7, 2020, from <https://www.cakex.org/documents/2016-city-imperial-beach-sea-level-rise-assessment>
- A3GEO. (2019). *Remedial Alternatives Report: Corte Madera Creek Levee Evaluation. About the ART Bay Shoreline Flood Explorer*. (n.d.). Retrieved November 4, 2020, from <https://explorer.adaptingtorisingtides.org/about>
- About the Project—BayWAVE. (2020). County of Marin. <https://www.marincounty.org/main/marin-sea-level-rise/baywave/about-the-project>
- Ackerly, D., Jones, A., Stacey, M., & Riordan, B. (2018). *San Francisco Bay Area Summary Report. California's Fourth Climate Change Assessment. (No. CCCA4-SUM-2018-005)*. University of California, Berkeley.
- Adaptation Planning. (2020, January). County of Marin. <https://www.marincounty.org/main/marin-sea-level-rise/baywave/adaptation-planning>
- AghaKouchak, A., Ragno, E., Love, C., & Moftakhari, H. (2018). Projected Changes in California's Precipitation Intensity-Duration-Frequency Curves. *Energy Commision of State of California: California, USA*.
- Are buyouts the best solution for sea-level rise? | Column. (n.d.). Tampa Bay Times. Retrieved October 4, 2020, from <https://www.tampabay.com/opinion/2019/12/20/are-buyouts-the-best-solution-for-sea-level-rise-column/>
- Barth, B. (2018). The Silver Lining of Sea-Level Rise. *American Planning Association*. <https://www.planning.org/planning/2018/aug/silverlining/>
- BayCAN Members' Adaptation Project Matrix. (202 C.E.). Bay Area Climate Adaptation Network. https://21d78982-07bf-412e-a9b4-6bb529cf0686.filesusr.com/ugd/700f86_eb435166c789403c9a04ba7cb5d7e99b.pdf
- Baye, P. (2020). *Conceptual designs for marsh-fringing beach nourishment to reduce wave erosion of Muzzi Marsh, Corte Madera Ecological Reserve, Marin County, California*. 25.
- BCDC, & ESA PWA. (2013). *Corte Madera Baylands Conceptual Sea Level Rise Adaptation Strategy*.
- Befus, K. M., Barnard, P. L., Hoover, D. J., Finzi Hart, J. A., & Voss, C. I. (2020). Increasing threat of coastal groundwater hazards from sea-level rise in California. *Nature Climate Change*. <https://doi.org/10.1038/s41558-020-0874-1>
- Berger, J. J. (2018). The 'Climate-Proofing' of Rotterdam. *The Solutions Journal*, 9(1). <https://www.thesolutionsjournal.com/article/climate-proofing-rotterdam/>
- Betancourt, M. (2020, June 29). Wildland firefighters are risking their mental health. *High Country News*. <https://www.hcn.org/issues/52.8/south-bureau-of-land-management-wildland-firefighters-are-risking-their-mental-health>
- Bikales, J. (2020). California protects homeowners from having fire insurance dropped - again. CalMatters. https://calmatters.org/environment/california-wild-fires/2020/11/california-homeowners-fire-insurance-dropped-again/?utm_source=CalMatters+Newsletters&utm_campaign=c8c72d54e5-WHATMATTERS_NEWSLETTER&utm_medium=email&utm_term=0_faa7be558d-c8c72d54e5-150812720&mc_cid=c8c72d54e5&mc_eid=307389eb7b
- Bill Text—AB-2800 *Climate change: Infrastructure planning*. (n.d.). California Legislative Information. Retrieved October 12, 2020, from https://leginfo.ca.gov/faces/billNavClient.xhtml?bill_id=201520160AB2800
- Bill Text—SB-1 California Environmental, Public Health, and Workers Defense Act of 2019. (n.d.). California Legislative Information. Retrieved October 12, 2020, from http://leginfo.ca.gov/faces/billNavClient.xhtml?bill_id=201920200SB1
- Bill Text—SB-379 *Land use: General plan: Safety element*. (n.d.). Retrieved November 4, 2020, from https://leginfo.ca.gov/faces/billTextClient.xhtml?bill_id=201520160SB379
- Bill Text—SB-1000 *Land use: General plans: Safety and environmental justice*. (n.d.). California Legislative Information. Retrieved October 13, 2020, from https://leginfo.ca.gov/faces/billNavClient.xhtml?bill_id=201520160SB1000
- Boulder County. (2011). Boulder County Community Wildfire Protection Plan.
- Bridges, T. S., Burks-Copes, K. A., Bates, M. E., Collier, Z. A., Fischenich, J. C., Piercy, C. D., Russo, E. J., Shafer, D. J., Suedel, B. C., & Gailani, J. Z. (2015). *Use of natural and nature-based features (NNBF) for coastal resilience*. US Army Engineer Research and Development Center, Environmental Laboratory ...
- CAL FIRE. (2018). *Strategic Fire Plan for California*. State Board of Forestry and Fire Protection and CAL FIRE.
- Cal-Adapt. (n.d.). Retrieved November 4, 2020, from <https://cal-adapt.org/tools/extreme-heat/>
- California Adaptation Planning Guide (p. 282). (2020). The California Governor's Office of Emergency Services. <https://www.caloes.ca.gov/HazardMitigation-Site/Documents/CA-Adaptation-Planning-Guide-FINAL-June-2020-Accessible.pdf>
- California Building Standards Commission. (n.d.). *California Building Standards Code*. Retrieved November 4, 2020, from <https://www.dgs.ca.gov/BSC/Codes#/@ViewBag.JumpTo>
- California Coastal Commission. (2018). *California Coastal Commission Sea Level Rise Policy Guidance*.
- California Legislative Information. (n.d.). *California Government Code § 65302(g)(4)*. Retrieved March 10, 2020, from http://leginfo.ca.gov/faces/codes_displaySection.xhtml?sectionNum=65302.&lawCode=GOV
- California Public Utilities Commission. (2020, July 16). *CPUC Requires Wireless Companies to Better Serve Customers in Emergencies* [Press Release].
- California State Responsibility Areas. (n.d.). Retrieved November 4, 2020, from <https://www.arcgis.com/home/item.html?id=5ac1dae3cb2544629a845d9a19e83991>
- California Wildfires Have Burned 4 Million Acres And The Season Isn't Over Yet. (n.d.). NPR.Org. Retrieved October 16, 2020, from <https://www.npr.org/2020/10/04/920154138/california-wildfires-have-burned-4-millions-acres-and-the-season-isnt-over-yet>
- Carkin, B. A., Kayen, R. E., & Wong, Florence L. (2020). *Shoreline Retreat of the Corte Madera Marshes, 1853 to 2016, Marin County, California* (Open-File Report 2020-1074; Open-File Report). USGS.
- Center for Ocean Solutions, Stanford Woods Institute for the Environment. (2018). *Coastal California Adaptation Policy Briefs. Chapter 15.04—WILDLAND-URBAN INTERFACE CODE | Code of Ordinances | Corte Madera, CA | Municode Library*. (n.d.). Retrieved November 4, 2020, from https://library.municode.com/ca/corte_madera/codes/code_of_ordinances?nodeId=TIT15BUCO_CH15.04WIBAINCO
- City of Foster City. (2016). *Foster City Levee Protection Planning and Improvements Project: Draft EIR*. Urban Planning Partners, Inc.
- City of Foster City. (2020). *Levee Improvements Project (CIP 301-657)* | Foster City, California. <https://www.fostercity.org/publicworks/project/levee-improvements-project-cip-301-657>
- City of Imperial Beach. (2019). *City of Imperial Beach General Plan/Local Coastal Program Land Use Plan* [Revised Draft].
- Climate Change | Caltrans. (n.d.). Retrieved October 13, 2020, from <https://dot.ca.gov/programs/transportation-planning/office-of-smart-mobility-climate-change/climate-change>
- Corte Madera, CA | Data USA. (n.d.). Retrieved November 4, 2020, from <https://datausa.io/profile/geo/corte-madera-ca#about>
- Corte Madera Code of Ordinances—Municode Library. (n.d.). Retrieved September 11, 2020, from https://library.municode.com/ca/corte_madera/codes/code_of_ordinances
- Corte Madera Neighborhood Receives National Firewise Recognition. (2019, January 15). *Central Marin Fire Department*. <https://centralmarinfire.org/about/news/corte-madera-neighborhood-receives-national-firewise-recognition>
- County of Marin Community Development Agency. (2017). *Building Permit General Information*.
- Dalton, M., Chisholm Hatfield, S., & Petersen, A. "Sascha." (2018). *Tribal Climate Adaptation Guidebook Writing Team* (p. 124) [White Paper]. Oregon State University. <http://www.occri.net/projects/tribal-climate-adaptation-guidebook/>
- Denchak, M. (2019). *Green Infrastructure: How to Manage Water in a Sustainable Way*. NRDC. <https://www.nrdc.org/stories/green-infrastructure-how-manage-water-sustainable-way>
- Dodgen, D., Donato, D., Kelly, N., Greca, A. L., Morganstein, J., Reser, J., Ruzek, J., Schweitzer, S., Shimamoto, M. M., Tart, K. T., & Ursano, R. (2016). Ch. 8: Mental Health and Well-Being. *The Impacts of Climate Change on Human Health in the United States: A Scientific Assessment* (pp. 217–246). U.S. Global Change Research Program, Washington, DC. *mental-health-and-well-being*
- Draft Technical Report. (n.d.). Google Docs. Retrieved October 18, 2020, from https://docs.google.com/document/d/1XTJxab0-9AT-wUSQdsTQ3J90N5uz1zT-89V1G4xyEw/edit?usp=drive_fs&ouid=115108273571022536405&usp=embed_facebook
- Ebi, K. L., Balbus, J., Luber, G., Bole, A., Crimmins, A. R., Glass, G. E., Saha, S., Shimamoto, M. M., Trtanj, J. M., & White-Newsome, J. L. (2018). *Chapter 14: Human Health. Impacts, Risks, and Adaptation in the United States: The Fourth National Climate Assessment, Volume II*. U.S. Global Change Research Program. <https://doi.org/10.7930/NCA4.2018.CH14>
- Facebook, Twitter, options, S. more sharing, Facebook, Twitter, LinkedIn, Email, URLCopied!, C. L., & Print. (2017, December 16). *After California's most destructive fire season, a debate over where to rebuild homes*. Los Angeles Times. <https://www.latimes.com/local/lanow/la-me-ln-rebuilding-in-hazard-zones-20171216-story.html>
- FEMA. (2017). *Pre-Disaster Recovery Planning Guide for Local Governments* (FD 008-03).
- FIRESafe MARIN, Marin County California Fire Safe Council. (n.d.). Retrieved November 4, 2020, from <https://firesafemarin.org/about>
- Firewise USA - FIRESafe MARIN. (n.d.). Retrieved November 4, 2020, from <https://www.firesafemarin.org/firewise>
- Flood Protection | Corte Madera, CA - Official Website. (n.d.). Retrieved September 24, 2020, from <https://www.townofcortemadera.org/192/Flood-Protection>
- Frank, S. (2020). Community Risk Sharing Organizations for Wildfire Insurance in California. *Berkeley Public Policy Journal*, Spring 2020. <https://bppj.berkeley.edu/2020/04/14/spring-2020-journal-community-risk-sharing-organizations-for-wildfire-insurance-in-california/>
- General Plan | Corte Madera, CA - Official Website. (n.d.). Retrieved November 3, 2020, from <https://www.townofcortemadera.org/182/General-Plan>
- Georgetown Climate Center. (n.d.). *Managed Retreat Toolkit [Toolkit]*. Georgetownclimatecenter.Org. Retrieved October 4, 2020, from <https://www.georgetown-climate.org/adaptation/toolkits/managed-retreat-toolkit/introduction.html>
- Goals Project. (2015). *The Baylands and Climate Change: What We Can Do. Baylands Ecosystem Habitat Goals Science Update 2015, prepared by the San Francisco Bay Area Wetlands Ecosystem Goals Project*. California State Coastal Conservancy.
- Grannis, J. (2011). *Adaptation Toolkit: Sea-Level Rise and Coastal Land Use*. Georgetown Climate Center.
- Grannis, J., Swanson, E., Wyman, C., Shoaf, J., & Singer, M. (2011). *A Model Sea-Level Rise Overlay Zone For Maryland Local Governments (expert review draft)*. Georgetown Climate Center.
- Green Infrastructure. (n.d.). The Trust for Public Land. Retrieved November 3, 2020, from <https://www.tpl.org/how-we-work/green-infrastructure>
- Griggs, G., Arvai, J., Cayan, D., DeConto, R., Fox, J., Fricker, H. A., Kopp, R. E., Tebaldi, C., & Whiteman, E. A. (2018). *Rising seas in California: An update on sea-level rise science*. California Ocean Science Trust.
- Hauer, M. E. (2017). Migration induced by sea-level rise could reshape the US population landscape. *Nature Climate Change*, 7(5), 321–325. <https://doi.org/10.1038/nclimate3271>
- Hauer, M. E., Fussell, E., Mueller, V., Burkett, M., Call, M., Abel, K., McLeman, R., & Wrathall, D. (2020). Sea-level rise and human migration. *Nature Reviews Earth & Environment*, 1(1), 28–39. <https://doi.org/10.1038/s43017-019-0002-9>
- Headwaters Economics. (2016). *Land Use Planning to Reduce Wildfire Risk: Lessons from Five Western Cities*.
- Highway 1 Corridor In Tam Valley Transportation. (n.d.). Resilient CA. Retrieved October 13, 2020, from <https://resilientca.org/case-studies/Highway-1-Corridor-in-Tam-Valley-Transportation/>
- Ho, V. (2020, September 7). Homeless Californians face new crisis: Living outside in smoke-filled air. *The Guardian*. <http://www.theguardian.com/us-news/2020/sep/07/homeless-wildfire-smoke-breathing-california>
- Hoover, D. J., Odigie, K. O., Swarzenski, P. W., & Barnard, P. (2017). Sea-level rise and coastal groundwater inundation and shoaling at select sites in California, USA. *Journal of Hydrology: Regional Studies*, 11, 234–249. <https://doi.org/10.1016/j.ejrh.2015.12.055>
- International Code Council, Inc. (2017). *2018 International Wildland-Urban Interface Code*.
- Kass, J., Walker, J., Cayce, K., Senn, D., & Williams, M. (2011). *White Paper on Regional Landscape Characterization for Low Impact Development Site Suitability Analysis*. San Francisco Estuary Institute.
- Kimley Horn, & AECOM. (2018). *SR 37 Transportation and Sea level Rise Corridor Improvement Plan* (p. 150). <https://scta.ca.gov/wp-content/uploads/2018/02/SR-37-Corridor-Plan-with-appendix.pdf>
- Lacko, L. (2019). *Adaptation Land Use Planning: Guidance for Marin County Local Governments* (p. 82). County of Marin Community Development Agency.

- <https://www.marincounty.org/-/media/files/departments/cd/slr/alup0228.pdf?la=en>
- Law section. (n.d.). Retrieved November 4, 2020, from http://leginfo.legislature.ca.gov/faces/codes_displaySection.xhtml?sectionNum=65302.&lawCode=GOV
- Learn about Public Safety Power Shutoffs (PSPS). (n.d.). Retrieved November 9, 2020, from https://www.pge.com/en_US/residential/outages/public-safety-power-shutoff/learn-about-psps.page
- Local Coastal Program and General Plan Update (City of Imperial Beach). (n.d.). Nextdoor.Com. Retrieved November 4, 2020, from </agency-detail/ca/imperial-beach/city-of-imperial-beach/>
- Lustgarten, A. (2020a, July 23). The Great Climate Migration Has Begun. *The New York Times*. <https://www.nytimes.com/interactive/2020/07/23/magazine/climate-migration.html>
- Lustgarten, A. (2020b, September 15). How Climate Migration Will Reshape America. *The New York Times*. <https://www.nytimes.com/interactive/2020/09/15/magazine/climate-crisis-migration-america.html>
- Mann, M. L., Battlori, E., Moritz, M. A., Waller, E. K., Berck, P., Flint, A. L., Flint, L. E., & Dolfi, E. (2016). Incorporating Anthropogenic Influences into Fire Probability Models: Effects of Human Activity and Climate Change on Fire Activity in California. *PLOS ONE*, 11(4), e0153589. <https://doi.org/10.1371/journal.pone.0153589>
- Marin Audubon Society. (2020). *Tiscornia Marsh Project*. TISCORNIA MARSH PROJECT - SAN RAFAEL, MARIN COUNTY. <http://www.tiscorniamarsh.org/about.html>
- Marin Climate & Energy Partnership. (2016). *Town of Corte Madera Climate Action Plan*. Town of Corte Madera.
- Marin County Civil Grand Jury. (2011). *Disaster Preparedness in Marin: Are You Ready?*
- Marin County Civil Grand Jury. (2019). *Wildfire Preparedness: A New Approach*.
- Marin County Civil Grand Jury. (2020). *Climate Change: How Will Marin Adapt?* County of Marin.
- Marin County Department of Public Works. (2017). *Marin Shoreline Sea Level Rise Vulnerability Assessment*. Bay Watteront Adaptation & Vulnerability Evaluation.
- Marin County Fire Department. (2017). *Marin County Unit Strategic Fire Plan & Community Wildfire Protection Plan*.
- Marin County Multi-Jurisdictional Local Hazard Mitigation Plan (p. 338). (2019). Marin County Watershed Program. <https://www.marinwatersheds.org/sites/default/files/2020-07/Marin%20County%20Multi-Jurisdictional%20Local%20Hazard%20Mitigation%20Plan%202018.pdf>
- Marin Municipal Water District. (2016a). *MMWD Water Resources Plan 2040*. <https://www.marinwater.org/217/Water-Supply-Planning>
- Marin Municipal Water District. (2016b). *Urban Water Management Plan 2015 Update*.
- Merkel, K. (2005). *Baywide Eelgrass (Zostera Marina) Inventory in San Francisco Bay: Eelgrass Bed Characteristics and Predictive Eelgrass Model*. Prepared for the State of California Department of Transportation in Cooperation with NOAA Fisheries.
- National Disaster Recovery Framework, Second Edition. (n.d.). 59.
- National Fire Protection Association. (2013). *Community Wildfire Safety Through Regulation: A Best Practices Guide for Planners and Regulators*.
- National Research Council. (2012). *Sea-Level Rise for the Coasts of California, Oregon, and Washington: Past, Present, and Future*. <https://doi.org/10.17226/13389>
- Newberry, L. (2019, November 8). Paradise rebuilds, but fire safety sometimes takes a back seat to economic realities. *Los Angeles Times*. <https://www.latimes.com/california/story/2019-11-08/rebuilding-paradise-one-year-after-camp-fire>
- Newkirk, S., Veloz, S., Hayden, M., Battalio, B., Cheng, T., Judge, J., Heady, W., Leo, K., & Small, M. (2018). *Toward Natural Shoreline Infrastructure to Manage Coastal Change in California*. California's Fourth Assessment.
- Newkirk, Sarah, Sam Veloz, Maya Hayden, Walter Heady, Kelly Leo, Jenna Judge, Robert Battalio, Tiffany Cheng, Tara Ursell, Mary Small. (The Nature Conservancy and Point Blue Conservation Science). 2018. *Toward Natural Infrastructure to Manage Shoreline*—Google Search. (n.d.). Retrieved September 14, 2020, from [https://www.google.com/search?q=Newkirk%2C+Sarah%2C+Sam+Veloz%2C+Maya+Hayden%2C+Walter+Heady%2C+Kelly+Leo%2C+Jenna+Judge%2C+Robert+Battalio%2C+Tiffany+Cheng%2C+Tara+Ursell%2C+Mary+Small.++\(The+Nature+Conservancy+and+Point+Blue+Conservation+Science\).+2018.+Toward+Natural+Infrastructure+to+Manage+Shoreline&rlz=1C5CHFA_enUS714US717&oq=Newkirk%2C+Sarah%2C+Sam+Veloz%2C+Maya+Hayden%2C+Walter+Heady%2C+Kelly+Leo%2C+Jenna+Judge%2C+Robert+Battalio%2C+Tiffany+Cheng%2C+Tara+Ursell%2C+Mary+Small.++\(The+Nature+Conservancy+and+Point+Blue+Conservation+Science\).+2018.+Toward+Natural+Infrastructure+to+Manage+Shoreline&q=chrome..69i57.446j0j4&sourceid=chrome&ie=UTF-8](https://www.google.com/search?q=Newkirk%2C+Sarah%2C+Sam+Veloz%2C+Maya+Hayden%2C+Walter+Heady%2C+Kelly+Leo%2C+Jenna+Judge%2C+Robert+Battalio%2C+Tiffany+Cheng%2C+Tara+Ursell%2C+Mary+Small.++(The+Nature+Conservancy+and+Point+Blue+Conservation+Science).+2018.+Toward+Natural+Infrastructure+to+Manage+Shoreline&rlz=1C5CHFA_enUS714US717&oq=Newkirk%2C+Sarah%2C+Sam+Veloz%2C+Maya+Hayden%2C+Walter+Heady%2C+Kelly+Leo%2C+Jenna+Judge%2C+Robert+Battalio%2C+Tiffany+Cheng%2C+Tara+Ursell%2C+Mary+Small.++(The+Nature+Conservancy+and+Point+Blue+Conservation+Science).+2018.+Toward+Natural+Infrastructure+to+Manage+Shoreline&q=chrome..69i57.446j0j4&sourceid=chrome&ie=UTF-8)
- Norfolk's Revised Zoning Ordinance Aims to Improve Flood Resilience. (n.d.). Retrieved October 4, 2020, from <https://pew.org/2CDnsgg>
- Nur, N., Wood, J., Elrod, M., & Schmidt, A. (2018). Guiding restoration of upland transition zones to benefit tidal marsh wildlife. *Point Blue Conservation Science*, 22.
- Ocean Protection Council. (2018). *State of California Sea-Level Rise Guidance 2018 Update*.
- Office of the County Administrator. (2019). *Marin Wildfire Prevention Authority and Parcel Tax Initiative*. County of Marin.
- Petersen, A. "Sascha." (n.d.). *Climate Change and the Jamestown S'Klallam Tribe: A Customized Approach to Climate Vulnerability and Adaptation Planning*.
- Plane, E., Hill, K., & May, C. (2019). A Rapid Assessment Method to Identify Potential Groundwater Flooding Hotspots as Sea Levels Rise in Coastal Cities. *Water*, 11(11), 2228. <https://doi.org/10.3390/w11112228>
- Planning and Investing for a Resilient California: A Guidebook for State Agencies (p. 68). (2018). Governor's Office of Planning and Research. https://opr.ca.gov/docs/20180313-Building_a_Resilient_CA.pdf
- Planning Considerations: Evacuation and Shelter-in-Place—Guidance for State, Local, Tribal and Territorial Partners. (n.d.). 64.
- Podesta, J. (2019, July 25). The climate crisis, migration, and refugees. *Brookings*. <https://www.brookings.edu/research/the-climate-crisis-migration-and-refugees/>
- Point Blue Conservation Science, San Francisco Estuary Institute, & County of Marin. (2019). *Sea Level Rise Adaptation Framework: A user guide to planning with nature as demonstrated in Marin County*.
- Pre-Disaster Recovery Planning Guide for Local Governments. (n.d.). 102.
- Preparing California for Extreme Heat: Guidance and Recommendations. (n.d.). 30.
- Randy Billings. (2019, September 10). New rules would reward developers in Portland who plan for sea level rise. *Press Herald*. <https://www.pressherald.com/2019/09/10/new-program-would-reward-developers-in-portland-who-plan-for-sea-level-rise/>
- Raucher, R. (2013). *Evaluating Adaptation Options: Assessing Cost, Effectiveness, Co-benefits, and Other Relevant Considerations* [CCRD White Paper]. United States Agency for International Development (USAID).
- Resilience Hubs. (n.d.). Resilience Hubs. Retrieved October 10, 2020, from <http://resilience-hub.org/>
- Resilience Hubs Can Help Communities Thrive—And Better Weather Disasters. (n.d.). Retrieved October 15, 2020, from <https://pew.org/2UTg7Ti>
- Resilient Zoning. (n.d.). Wetlands Watch. Retrieved October 6, 2020, from <http://wetlandswatch.org/resilient-zoning>
- Rincon, P. (2019a, March 4). California fires "can now happen any year." *BBC News*. <https://www.bbc.com/news/science-environment-47444463>
- Rincon, P. (2019b, March 4). Climate change: California wildfires "can now happen in any year." *BBC News*. <https://www.bbc.com/news/science-environment-47444463>
- Road to Recovery Webinar: Double the Trouble: Evacuations During COVID-19. (n.d.). Retrieved October 5, 2020, from <https://www.enotrans.org/event/road-to-recovery-webinar-double-the-trouble-evacuations-during-covid-19/>
- Rotzoll, K., & Fletcher, C. H. (2013). Assessment of groundwater inundation as a consequence of sea-level rise. *Nature Climate Change*, 3(5), 477–481. <https://doi.org/10.1038/nclimate1725>
- SFEI and SPUR. (2019). *San Francisco Bay Shoreline Adaptation Atlas: Working with Nature to Plan for Sea Level Rise Using Operational Landscape Units* (Publication #915). San Francisco Estuary Institute.
- SFEI, & Baye, P. (2020). *New Life for Eroding Shorelines: Beach and Marsh Edge Change in the San Francisco Estuary* (SFEI Publication #984). San Francisco Estuary Institute.
- Shirazi, S., Baca, E., McCormick, M., & Litchney, S. (n.d.). *State of California General Plan Guidelines* (p. 404). Governor's Office of Planning and Research. https://opr.ca.gov/docs/OPR_COMPLETE_7.31.17.pdf
- Shirzaei, M., & Bürgmann, R. (2018). Global climate change and local land subsidence exacerbate inundation risk to the San Francisco Bay Area. *Science Advances*, 4(3), eaap9234. <https://doi.org/10.1126/sciadv.aap9234>
- State Key Findings—California Climate Change Assessment. (n.d.). Retrieved September 14, 2020, from <https://climateassessment.ca.gov/state/overview/>
- Sustainable Marin: Summary of the 2007 Marin Countywide Plan (p. 112). (2008). Marin County Community Development Agency. https://www.marincounty.org/-/media/files/departments/cd/planning/currentplanning/publications/county-wide-plan/cwp_execsum.pdf
- Syphard, A. D., Massada, A. B., Butsic, V., & Keeley, J. E. (2013). Land Use Planning and Wildfire: Development Policies Influence Future Probability of Housing Loss. *PLOS ONE*, 8(8), e71708. <https://doi.org/10.1371/journal.pone.0071708>
- Table of Sales Taxes Received by Fiscal Year. (n.d.). <https://www.townofcortemadera.org/ArchiveCenter/ViewFile/Item/2024>
- The California Environmental Justice Alliance, & PlaceWorks Inc. (2017, September 12). SB 1000 Toolkit: Planning for Healthy Communities. *California Environmental Justice Alliance*. <https://caleja.org/2017/09/sb-1000-toolkit-release/>
- The City and County of San Francisco. (2020). *Guidance for Incorporating Sea Level Rise into Capital Planning* [2020 Update]. <https://onesanfrancisco.org/sea-level-rise-guidance>
- Town of Corte Madera. (2008). *General Plan Update Draft Environmental Impact Report*. Ordinance No. 904, (2008).
- Town of Corte Madera. (2014). *Corte Madera Inn Rebuild Project Draft Environmental Impact Report* (State Clearinghouse Number 2014042069).
- Town of Corte Madera. (2015). *Housing Element for the Town of Corte Madera 2015-2023*.
- Town of Corte Madera. (2019). *Annual Financial Report*.
- Town of Corte Madera General Plan. (2009). <https://www.townofcortemadera.org/182/General-Plan>
- Town of Paradise California. (2019). *Long-Term Community Recovery Plan*. Urban Design Associates. https://issuu.com/makeitparadise/docs/2350rptbook_final190624?e=37113742/70809073
- Town of Paradise Long-Term Community Recovery Plan. (n.d.). Issuu. Retrieved October 9, 2020, from https://issuu.com/makeitparadise/docs/2350rptbook_final190624/1
- Transportation Research Board. (2008). *The Role of Transit in Emergency Evacuation: Special Report 294*. The National Academies Press. <https://doi.org/10.17226/12445>
- Underwater: Rising Seas, Chronic Floods, and the Implications for US Coastal Real Estate. (2018). Union of Concerned Scientists. <https://www.ucsusa.org/resources/underwater>
- Urban Sustainability Directors Network. (2019). *Guide to Developing Resilience Hubs*.
- U.S. Army Corps of Engineers. (2018). *Corte Madera Creek Draft Environmental Impact Statement/Environmental Impact Report* (Corte Madera Creek Flood Risk Management Project).
- U.S. Dept. of Homeland Security. (2016). *National Disaster Recovery Framework*.
- US EPA, OAR. (2014, September 15). *Patient Exposure and the Air Quality Index* [Collections and Lists]. US EPA. <https://www.epa.gov/pmcourse/patient-exposure-and-air-quality-index>
- US EPA, OW. (2015a, April 24). *Green Infrastructure* [Collections and Lists]. US EPA. <https://www.epa.gov/green-infrastructure>
- US EPA, OW. (2015b, October 1). *Green Infrastructure for Climate Resiliency* [Overviews and Factsheets]. US EPA. <https://www.epa.gov/green-infrastructure/green-infrastructure-climate-resiliency>
- US EPA, OW. (2015c, October 12). *Sanitary Sewer Overflow (SSO) Frequent Questions* [Other Policies and Guidance]. US EPA. <https://www.epa.gov/npdes/sanitary-sewer-overflow-ssofrequent-questions>
- US EPA, OW. (2016, June 14). *Green Infrastructure in the Semi-Arid West (Rocky Mountains, Southwest)* [Collections and Lists]. US EPA. <https://www.epa.gov/green-infrastructure/green-infrastructure-semi-arid-west>
- USAID. (2013). *Evaluating Adaptation Options: Assessing Cost, Effectiveness, Co-Benefits, and Other Relevant Considerations*. Climatelinks. <https://www.climatelinks.org/resources/evaluating-adaptation-options-assessing-cost-effectiveness-co-benefits-and-other-relevant>

- USC Sea Grant, & USC Dornsife. (n.d.). *Groundwater inundation hazards and socioeconomic impacts due to sea-level rise across the California coast*. Retrieved November 3, 2020, from <http://dornsifefive.usc.edu/uscseagrant/opc-usgs-barnard-groundwater/>
- USGCRP. (2016). *The Impacts of Climate Change on Human Health in the United States: A Scientific Assessment* (pp. 1–312). U.S. Global Change Research Program, Washington, DC. [executive-summary.html](#)
- USGCRP. (2018). *Fourth National Climate Assessment*. <https://nca2018.globalchange.gov><https://nca2018.globalchange.gov/chapter/14>
- Wahl, E. R., Zorita, E., Trouet, V., & Taylor, A. H. (2019). Jet stream dynamics, hydroclimate, and fire in California from 1600 CE to present. *Proceedings of the National Academy of Sciences*, 116(12), 5393–5398. <https://doi.org/10.1073/pnas.1815292116>
- Weiland, S., Tröltzsch, J., Capriolo, A., Den Uyl, R. M., Jensen, A., Giordano, F., Hildén, M., Karali, E., Mäkinen, K., Nielsen, H., Penha-Lopes, G., & Russel, D. (2014). *BASE Evaluation Criteria for Climate Adaptation (BECCA)*.
- Welcome to Communities at Risk*. (n.d.). Retrieved November 9, 2020, from <https://osfm.fire.ca.gov/divisions/wildfire-planning-engineering/fire-plan/communities-at-risk/>
- Wildfire Evacuation Zones—Fire Department—County of Marin*. (n.d.). Retrieved November 4, 2020, from <https://www.marincounty.org/depts/fr/divisions/operations/wildfire-evacuation-zones>
- Wildfire Preparedness*. (n.d.). Retrieved November 4, 2020, from <https://www.firesafemarin.org/preparedness>
- WildfireBestPracticesGuide.pdf*. (n.d.). Retrieved October 6, 2020, from <https://www.nfpa.org/-/media/Files/Public-Education/By-topic/Wildland/WildfireBestPracticesGuide.ashx>

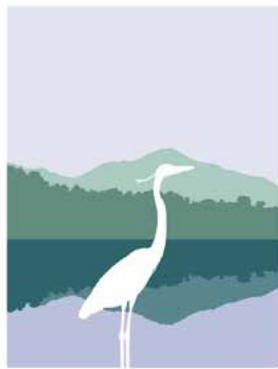

THE TOWN OF
CORTE MADERA

MARIN COUNTY CALIFORNIA

www.cortemaderaadapts.com